

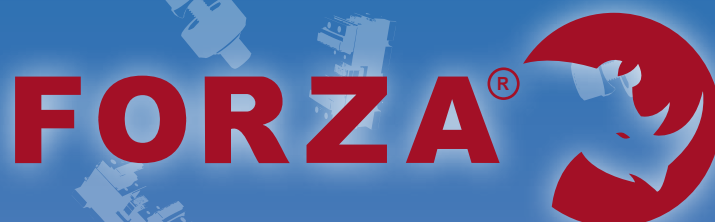

PREÇO E QUALIDADE

com a garantia do líder



2023

OFERTAS PERMANENTES



EXTRATOR SÉRIE 7500 - 2 PATAS



Extrator autocentrante ajustável com um único movimento.



EXTRATOR SÉRIE 7500 - 3 PATAS

Ref.	PVP 2023	Preço OFERTA
FZ7501	102,10	75,85
FZ7502	123,00	91,37
FZ7504	148,40	110,24
FZ7507	218,20	162,09
FZ7510	362,50	269,29

Ref.	PVP 2023	Preço OFERTA
FZ7501T	119,40	88,70
FZ7502T	163,20	121,23
FZ7504T	196,30	145,82
FZ7507T	290,10	215,50
FZ7510T	439,50	326,49

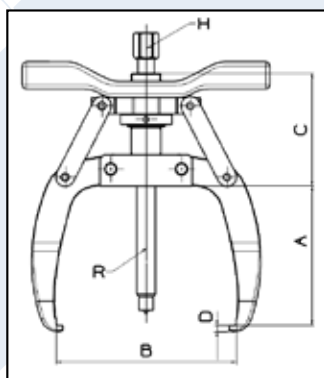

Caraterísticas técnicas

Ref.	A	Tm	B min	B max	C	D	H	R
FZ7501	68	1	20	95	40	3	11	M10 x 1,5
FZ7502	102	2	28	132	60	4,6	17	9/16" UNF18h
FZ7504	142	4	30	186	90	6,7	20	5/8" UNF18h
FZ7507	177	7	35	260	134	9,6	20	M18 x 1,5
FZ7510	215	10	84	300	126	11,9	22	M20 x 1

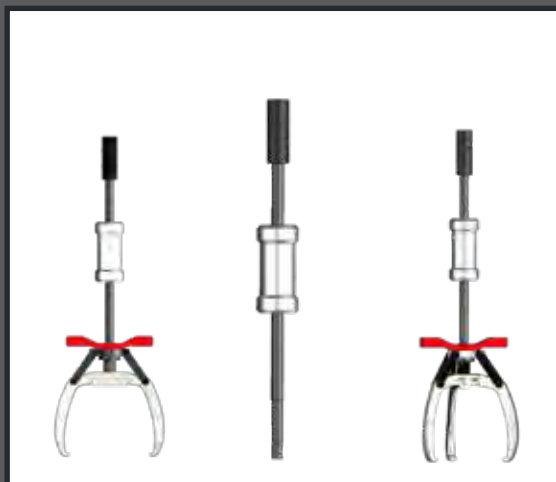

O extrator 7504 e 7504T oferecem a possibilidade de ser utilizado com barra de impacto 4393.

Ref.	PVP 2023	Preço OFERTA
FZ4393	148,00	109,94

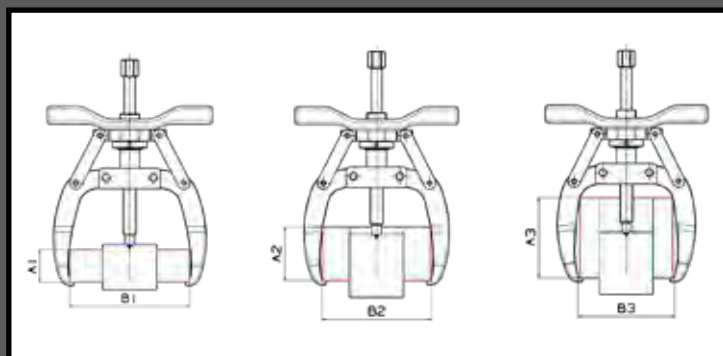

Medições de aberturas e alturas: o design das pernas permite capturar peças altas com grandes aberturas.

Ref.	A1	B1	A2	B2	A3	B3
FZ7501	30	90	40	82	68	40
FZ7502	35	132	60	120	90	105
FZ7504	60	186	90	165	140	125
FZ7507	55	260	105	220	165	180
FZ7510	95	300	135	255	195	205

EXTRATOR DE 2 PATAS RÍGIDAS

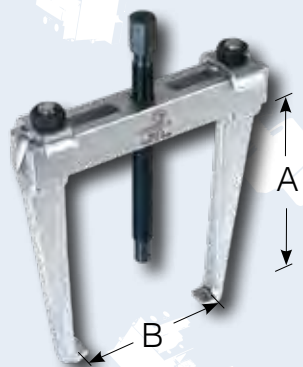

Ref.	A x B	PVP 2023	Preço OFERTA
FZ1001	50x60	64,90	48,21
FZ1002	80x80	84,10	62,47
FZ1003L	135x115	101,30	75,25
FZ1010	160x155	172,40	128,07
FZ1010L	220x145	184,80	137,28
FZ1015	220x195	215,50	160,09

EXTRATOR C/ALARGADORES EXTENSÍVEIS

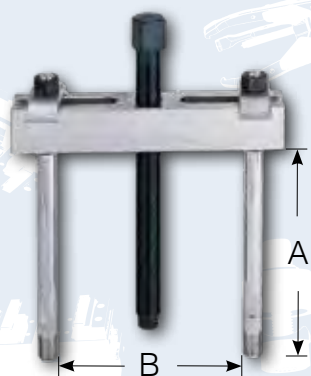

Montagem 1100S - 1200



Ref.	A x B	PVP 2023	Preço OFERTA
FZ1102S	115 x 110	64,50	47,91
FZ1103S	115 x 140	73,30	54,45
FZ1110S	175 x 195	146,60	108,90
FZ1115S	175 x 245	167,60	124,50

Ref.	A x B	PVP 2023	Preço OFERTA
FZ1202A	60 x 60	70,00	52,00
FZ1203A	80 x 80	91,80	68,19
FZ1204B	110 x 110	127,70	94,86
FZ1206B	134 x 155	260,00	193,14

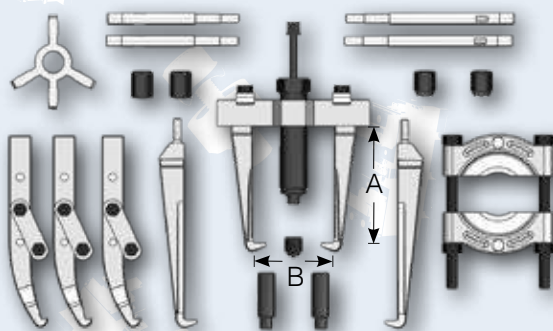

Ref.	PVP 2023	Preço OFERTA
FZC1005	944,50	701,63

O conjunto C1005 contém o fuso 150000E



A=160 / B=150	A=220 / B=150	A x B	A x B	A=225 / B=240	A=225 / B=240	
1012H	1012LH	150x175	332x175	2 Patas	1312TH	1204B

EXTRATOR GUILHOTINA SÉRIE 1200

CONJUNTO HIDRÁULICO 8 Tn





EXTRATOR DE 2/3 PATAS OSCILANTES



Combina con 2/3 patas

*Excepto

Ref.	A x B	PVP 2023	Preço OFERTA
FZ1300T*	55 x 70	49,90	37,07
FZ1301T	85 x 100	68,10	50,59
FZ1304T	135 x 150	102,00	75,99
FZ1307T	180 x 200	136,50	101,40
FZ1310T	300 x 310	309,20	229,69



FZ1308TH



FZ7308ALTH

Ref.	A x B	PVP 2023	Preço OFERTA
FZ1308TH	225 x 260	349,10	259,33
FZ7308LTH	225 x 280	476,20	353,75

EXTRATOR HIDRÁULICO 2/3 PATAS 8Tm

EXTRATOR AUTOCENTRANTE HIDRÁULICO 2/3 PATAS 12Tm

EXTRATOR MÚLTIPLO

EXTRATOR 2/3 PATAS REVERSÍVEL



Combina con 2/3 patas



Ref.	A x B	PVP 2023	Preço OFERTA
FZ1401LT	85 x 130	68,40	50,81
FZ1404LT	135 x 185	103,80	77,11
FZ1407LT	180 x 240	151,20	112,32

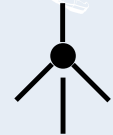
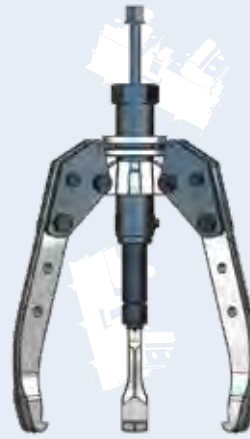

Combina con 2/3 patas

Ref.	A x B	PVP 2023	Preço OFERTA
FZ1312THA	225 x 260	565,20	419,86

EXTRATOR AUTOCENTRANTE 2/3 PATAS

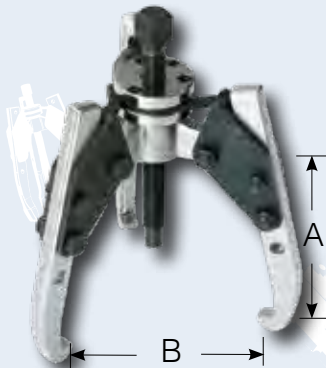

Combina con 2/3 patas

Ref.	A x B	PVP 2023	Preço OFERTA
FZ1301ALT	105 x 110	136,40	101,33
FZ1304ALT	185 x 175	176,00	130,74
FZ1307ALT	225 x 240	253,40	188,24

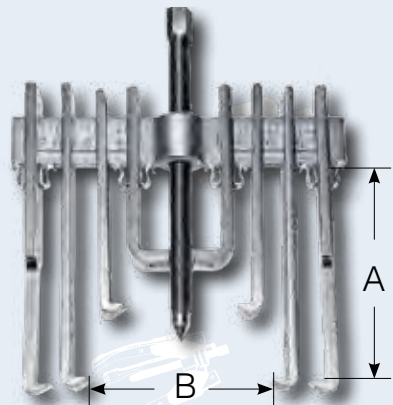

Ref.	A x B	PVP 2023	Preço OFERTA
FZ1805	140 x 173	159,50	118,49
FZ1810	182 x 250	227,20	168,78

EXTRATOR MÚLTIPLO EM ESTOJO



Ref.	Descrição	PVP 2023	Preço OFERTA
FZ1805-C	1805 em estojo	178,90	132,90
FZ1810-C	1810 em estojo	258,20	191,81

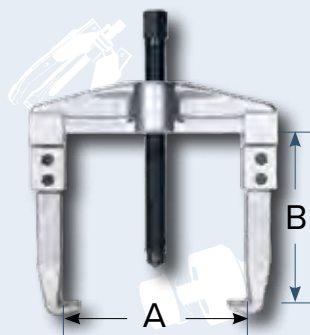

Ref.	A x B	PVP 2023	Preço OFERTA
FZ2410	100 x 95	81,50	60,54
FZ2415	100 x 135	86,40	64,18
FZ2420	150 x 165	135,50	100,66
FZ2425	155 x 190	140,70	104,52
FZ2430	205 x 240	219,10	162,76
FZ2435	200 x 350	237,60	176,50

EXTRATOR DE PATAS FINAS

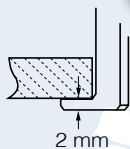
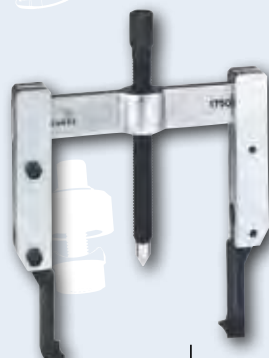
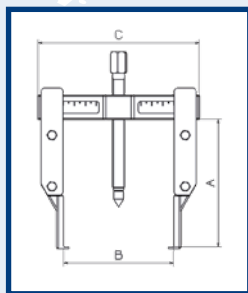

Assegure-se de que as patas estão introduzidas o máximo possível.

Ref.	A x B	PVP 2023	Preço OFERTA
FZ1750	145 x 140	160,00	118,93



Até 1Tn

Ref.	Conteúdo	PVP 2023	Preço OFERTA
FZ9300K	9300-9300T 9301-9301T	165,50	122,94

EXTRATOR LIGEIRO AUTOCENTRANTE 2740



As patas engrenam com a porca de suporte do fuso, o que faz com que todas as pernas se movimentem ao mesmo tempo.



Ref.	A x B	PVP 2023	Preço OFERTA
FZ2741	80 x 80	41,50	30,83
FZ2743	116 x 122	51,30	38,11
FZ2745	160 x 161	76,60	56,90
FZ2748	200 x 202	91,60	68,05

Ref.	A x B	PVP 2023	Preço OFERTA
FZ2741T	80 x 80	52,80	39,22
FZ2743T	116 x 122	62,40	46,35
FZ2745T	160 x 161	96,00	71,31
FZ2748T	200 x 202	116,20	86,32

EXTRATOR UNIVERSAL DE 2 PATAS RÍGIDAS

JOGO DE EXTRATORES 9300K

EXTRATOR LIGEIRO AUTOCENTRANTE 2740T



WWW.FORZA.ES

I.V.A. NÃO INCLUIDO / CAMPANHA VÁLIDA ATÉ 31 DE DEZEMBRO DE 2023





JOGO EXTRATOR PATA FINA



Jogo completo de extratores de pata muito fina.

Com três alturas de flange.

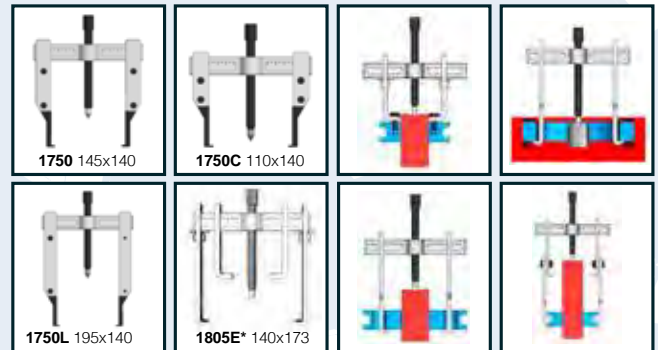

Ref.	Descrição	PVP 2023	Preço OFERTA
FZ9075	Extrator 1750 2 patas 175040 2 patas 175060 2 patas 180531 2 patas 180532	422,70	314,01

EXTRATOR TIPO TESOURA

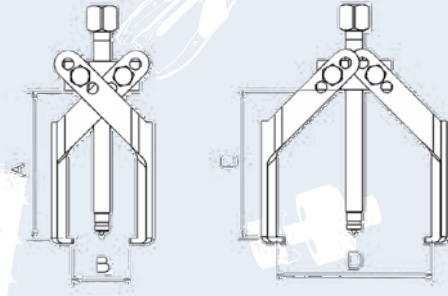

Ref.	A	B	C	D	PVP 2023	Preço OFERTA
FZ2641	90	55	90	95	78,20	58,09
FZ2642	125	70	120	125	98,10	72,87
FZ2643	125	80	160	125	117,50	87,29



Ponte + guilhotina + patas + alargadores + protetor de ponto + porcas de ligação.

Ref.	Descrição	PVP 2023	Preço OFERTA
FZC1110SC	10Tn	450,30	334,51



JOGO EXTRATORES 10TN



WWW.FORZA.ES

JOGO EXTRATORES COM
ADAPTADORES ROSCADOS



Ref.	Descrição	PVP 2023	Preço OFERTA
FZ9082	Jogo de extratores com alargadores 1102 + guilhotina 1202A + 2 patas para 1002 + adaptadores M6 a M14, 1/2" e 3/8"	290,10	215,50

JOGO EXTRATORES 9084



O totalidade dos extratores que se podem montar estão avaliados em **808,00€**.

Ref.	Descrição	PVP 2023	Preço OFERTA
FZ9084	2/4Tn.	449,90	334,21

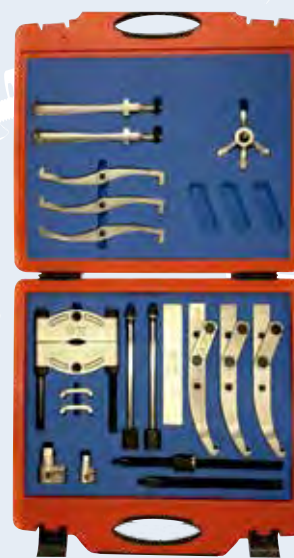
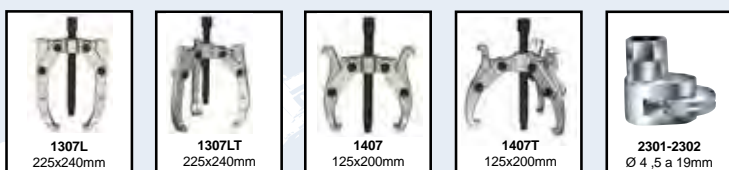
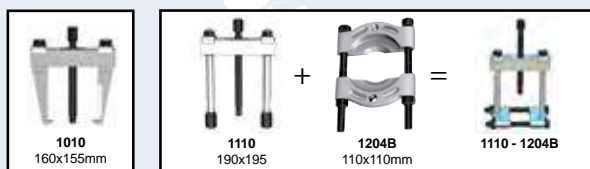

Ref.	Descrição	PVP 2023	Preço OFERTA
FZ9087	FZ1010 - FZ1110 - FZ1204B - FZ1307L - FZ1307LT - FZ1407 - 1407T - 2301 - 2302	778,60	578,39

I.V.A. NÃO INCLUIDO / CAMPANHA VÁLIDA ATÉ 31 DE DEZEMBRO DE 2023



JOGO EXTRATORES 7 Tn



EXTRATOR INTERIOR E EXTERIOR COM BARRA DE IMPACTO

Exteriores: 0 - 75 mm

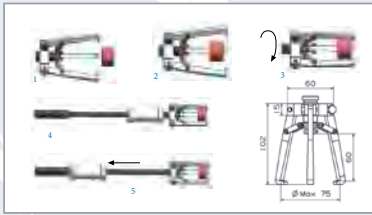

Interiores: 25 - 100 mm

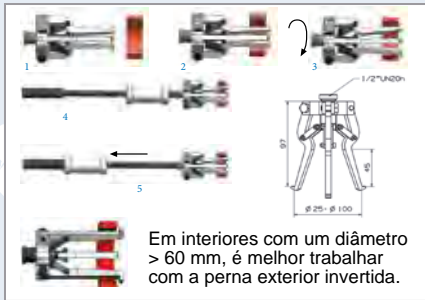

Em interiores com um diâmetro > 60 mm, é melhor trabalhar com a perna exterior invertida.

Para exteriores até 7mm e interiores de 25 a 100mm.

Com dois conjuntos de patas interiores y exteriores, inclui dois jogos de 3 patas.

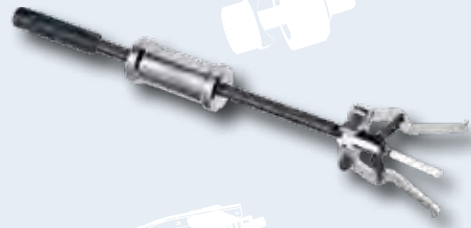

Ref.	Descrição	PVP 2023	Preço OFERTA
FZ4702C	Extrator 4702 + 4390	227,60	169,07

EXTRATOR DE INTERIORES



+ 2 Patas Ref. 750405



Ref.	PVP 2023	Preço OFERTA
FZ7504I	170,50	126,66
FZ7504IT	227,30	168,85

Ref.	PVP 2023	Preço OFERTA
FZ7504IC	195,10	144,93
FZ7504ITC	264,20	196,26

EXTRATOR DE INTERIORES e EXTERIORES

EXTRATOR DE INTERIORES E EXTERIORES COM BARRA DE IMPACTO

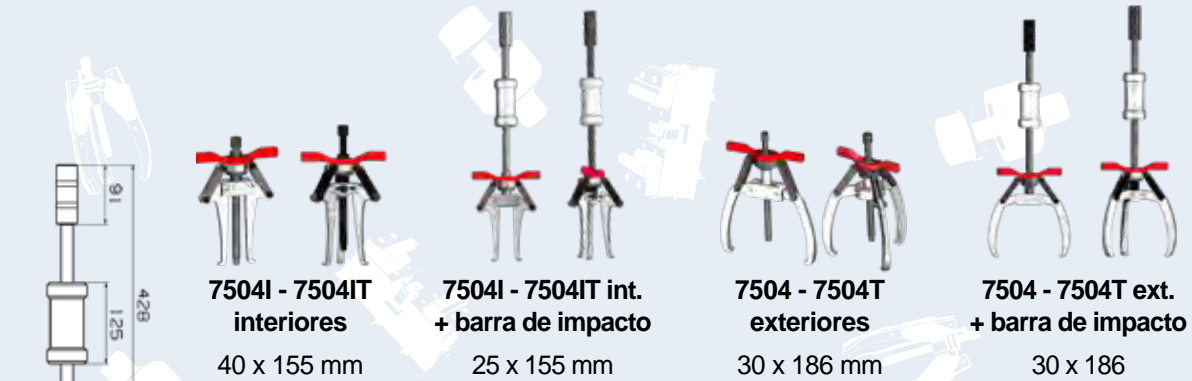

Ref.	Descrição	PVP 2023	Preço OFERTA
FZC7504B	Extrat. Ext-Int, 2 patas com barra de impacto FZ4393	316,60	235,19
FZC7504TB	Extrat. Ext-Int, 3 patas com barra de impacto FZ4393	385,70	286,52



Exterior: 0 - 75 mm
Interiores: 12 - 100 mm

Ref.	Descrição	PVP 2023	Preço OFERTA
FZ4720	Extrator 4702C + pinças int. Ø12-25	434,90	323,07



Contém: 4312-4315-4320-4390-4702

JOGO DE EXTRATOR DE INTERIORES E EXTERIORES

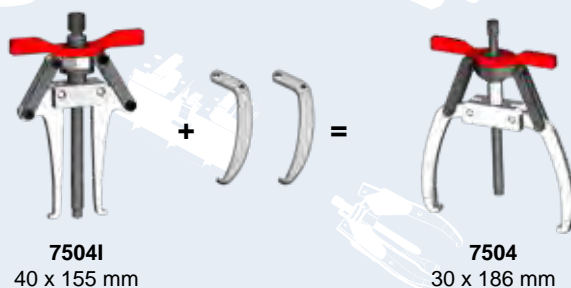

Esta mala contém o extrator de 7504IC.

Ref.	Descrição	PVP 2023	Preço OFERTA
FZ7504KI	Extrator Ext. - Int. 2 patas	248,30	184,45

Permite ser montada:

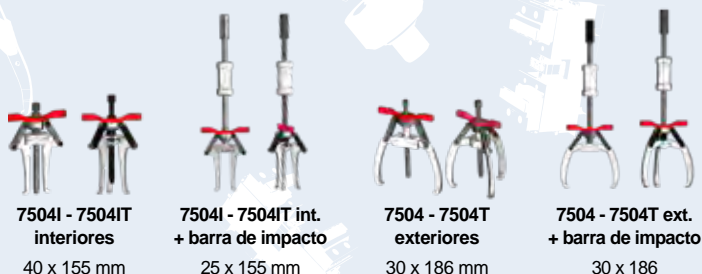

Ref.	Descrição	PVP 2023	Preço OFERTA
FZ7504KIT	Extrator Ext. - Int. 2/3 patas com barra de impacto	558,40	414,81



JOGO DE EXTRATOR DE INTERIORES E EXTERIORES COM BARRA DE IMPACTO



JOGO DE EXTRATORES INTERIORES DE PINÇA SÉRIE 2500



Com dois sistemas de extracção: Ponte e viga de impacto



Ref.	ØA	PVP 2023	Preço OFERTA
25-1	5 - 34	539,00	400,40

Ref.	Ø	PVP 2023	Preço OFERTA
43-22	5 - 45	625,10	464,36

JOGO DE EXTRATORES INTERIORES DE PINÇA SÉRIE 4300

EXTRATOR DE PASSADORES ROSCADOS

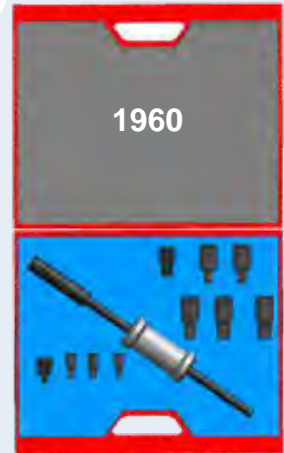

Ref.	Adaptadores	PVP 2023	Preço OFERTA
FZ1950	M4, M5, M6, M8, M10	143,00	106,23
FZ1960	M6 a M20 + 3/8" - 5/8"	233,00	173,09

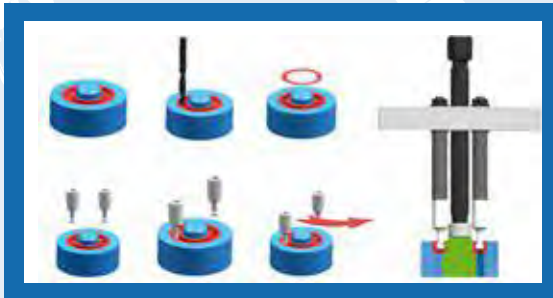

Ref.	A	PVP 2023	Preço OFERTA
FZ4100	20 a 95mm	189,00	140,40
FZ4105	35 a 117mm	275,40	204,58

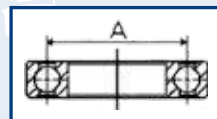

EXTRATOR DE ROLAMENTOS DE BOLAS

PRENSA MASTER



Principalmente utilizado quando o rolamento não é acessível por fora nem por dentro.

Ref.	A x B	PVP 2023	Preço OFERTA
FZ1600-1	105x116	307,20	228,21
FZ1600A	125x157	998,80	741,97

PRENSA MASTER



Pega incluída.

Construída em ferro fundido nodular. Com mordentes duros graduados.

Ref.	A x B	PVP 2023	Preço OFERTA
FZ33/100M	105x116	298,50	221,74
FZ33/125M	125x157	398,00	295,66
FZ33/150M	150x190	448,00	332,80

TORNO DE BANCADA



Ref.	Abertura x altura	PVP 2023	Preço OFERTA
FZ88/100N	100 x 62	169,60	161,52
FZ88/125N	150 x 80	207,70	197,81
FZ88/150N	200 x 91	388,00	369,52



PRENSA RÁPIDA



O fácil manuseamento permite-lhe prender e soltar a peça em décimos de segundo. Inclui dois conjuntos de maxilares macios.

Ref.	A x B	PVP 2023	Preço OFERTA
FZ38/103	275 x 100	495,00	556,19

PRENSA STANDARD

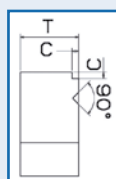

Boca móvel com prismas a 90° e graduação.

Ref.	T x C	PVP 2023	Preço OFERTA
FZ82/85	25 x 3	156,00	115,89
FZ82/100	40 x 4	230,50	171,23
FZ82/125	40 x 4,5	269,90	200,50
FZ82/150	40 x 6	305,00	226,57

CHAVE RÁPIDA



Chave rápida com roquete

Ref.	Medida	PVP 2023	Preço OFERTA
FZ821030	roquete de 13 a 30mm.	68,00	50,51



CHAVES PARA PORCAS KM CURTAS

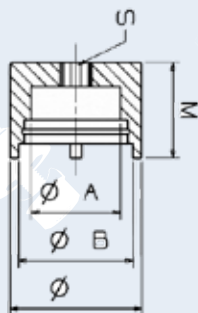

Têm praticamente o mesmo diâmetro da porca.
Permite a extração em espaços profundos e confinados.

Ref.	KM	ØB	ØC	M	S	ØKM	PVP 2023	Preço OFERTA
961041	KM4	28,5	34	40	1/2"	32	37,50	28,13
961051	KM5	34,5	40	40	1/2"	38	39,00	29,25
961061	KM6	41,5	47	40	1/2"	45	41,50	31,13
961071	KM7	48,5	54	40	1/2"	52	45,00	33,75
961081	KM8	53,5	60	40	1/2"	58	48,50	36,38
961091	KM9	58	67	40	1/2"	65	53,0	39,775
961101	KM10	65	72	40	1/2"	70	56,00	42,00
961111	KM11	70,5	77	50	3/4"	75	75,00	56,25
961121	KM12	76	82	50	3/4"	80	89,50	67,13
961131	KM13	80	87	50	3/4"	85	103,00	77,25
961141	KM14	86	94	50	3/4"	92	112,00	84,00

MALA 96800

Conteúdo da mala:
de KM4 a KM10 curtas
961041 - 961051 - 961061 - 961071
961081 - 961091 - 961101

Ref.	Conteúdo	PVP 2023	Preço OFERTA
96800	KM4 - KM10 sem prolongador	320,50	238,09

**MALA 96801**

Conteúdo da mala:
de KM4 a KM7 completas
961041 - 961042 / 961051 - 961052
961061 - 961062 / 961071 - 961072

Ref.	Conteúdo	PVP 2023	Preço OFERTA
96801	KM4 - KM7 com prolongador	388,50	288,60

**MALETÍN 96802**

Conteúdo da mala:
de KM4 a KM10 completas
961041 - 961042 / 961051 - 961052
961061 - 961062 / 961071 - 961072
961081 - 961082 / 961091 - 961092 / 961101 - 961102

Ref.	Conteúdo	PVP 2023	Preço OFERTA
96802	KM4 - KM10 com alargador	783,30	581,88



LIMAS PARA ROSCAS



Ref.	Descrição	PVP 2023	Preço OFERTA
FZ59301	Withworth 11-12-13-14-16-18-20-24	27,10	25,81
FZ59302	Withworth 9-10-12-16-20-27-28-32	27,10	25,81
FZ59304	Métricas 0,75-1-1,25-1,50-1,75-2-2,50-3	27,10	25,81
FZ5930	Jogo: inclui 59301, 59302, 59304	63,90	60,86



Ref.	Medidas	PVP 2023	Preço OFERTA
FZNEST	Ext. Ø 4-13	47,10	44,86



Girar o punho serrilhado A para abrir as lâminas. Coloque a rosca danificada dentro do restaurador.

Girar o punho serrilhado A para fechar as lâminas dentro do segmento. Aplique uma tensão ligeira.

Girar o restaurador na direcção da rosca.



Ref.	Medidas	PVP 2023	Preço OFERTA
FZNES1A	Ø 4-18	111,10	105,81
FZNES2	Ø 17-38	161,10	153,43

JOGO DE RESTAURADORES INTERIORES



Ref.	Conteúdo	PVP 2023	Preço OFERTA
FZNES12	Exteriores de 4 a 38 mm	284,50	270,95



Ref.	Medidas	PVP 2023	Preço OFERTA
FZNES1012	Ext. 4 a 18mm Int. 8 a 16mm	351,50	334,76

JOGO DE RESTAURADORES EXTERIORES E INTERIORES



Ref.	Medidas	PVP 2023	Preço OFERTA
FZNES1025	Interiores 8 a 32 mm Exteriores 4 a 38 mm	847,00	806,67

RESTAURADOR DE ROSCAS EXTERIOR

RESTAURADOR DE ROSCAS EXTERIOR

JOGO DE RESTAURADORES INTERIORES E EXTERIORES



WWW.FORZA.ES

I.V.A. NÃO INCLUIDO / CAMPANHA VÁLIDA ATÉ 31 DE DEZEMBRO DE 2023





EXTRATOR DE PARAFUSOS DE ROSCA ESQUERDA



Ref.	Medidas	PVP 2023	Preço OFERTA
FZT51300	5 peças de 4 a 20mm.	14,00	10,40

EXTRATOR PARAFUSOS DE ROSCA ESQUERDA



Contém: 5011R-5012R-5013R-5014R-5015R

Ref.	Medidas	PVP 2023	Preço OFERTA
FZ5010RE	5 extrac. de rosca esquerda Cr.V	26,50	19,69



Ref.	Descrição	PVP 2023	Preço OFERTA
FZGG005	Ajuda a soltar e apertar parafusos	8,60	8,19



Contém: 5011-5012-5013-5014-5015

Ref.	Medidas	PVP 2023	Preço OFERTA
FZ5010	5 extrac. machos estriados	48,60	36,10

Ref.	Medidas	PVP 2023	Preço OFERTA
FZ5010C	5010+brocas e guías duplas esquerdas	97,80	72,65

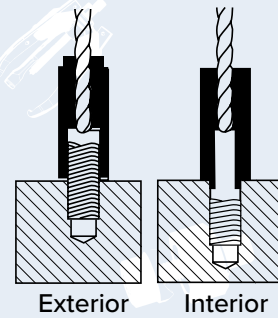

Ref.	Medidas	PVP 2023	Preço OFERTA
FZ5010CD	5010+brocas e guías duplas: int. e ext.	102,10	75,85

Ref.	Medidas	PVP 2023	Preço OFERTA
FZ5010KI	5010 + brocas e guías duplas esquerdas	126,30	93,82



EXTRATOR DE RÓTULAS



Ref.	Ø mín - máx	PVP 2023	Preço OFERTA
FZ2301	4,5 - 9,5	41,20	30,61
FZ2302	8 - 19	65,30	48,51

EXTRATOR DE RÓTULAS



Ref.	Ø mín - máx	PVP 2023	Preço OFERTA
FZ5135	4,5 - 9,5	35,00	26,00

EXTRATOR DE PARAFUSOS E RÓTULAS

Jogo de extratores de rótulas e parafusos partidos.
En mala de plástico de cor vermelha.



Ref.	Ø mín - máx	PVP 2023	Preço OFERTA
FZ9001	4,5 - 9,5	141,00	104,74



5010N Contém:
5011N - 5012N - 5013N - 501N

Ref.	Medidas	PVP 2023	Preço OFERTA
FZ5010N	M6 - M16	73,70	54,75

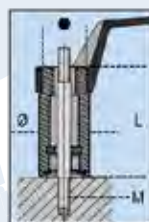

Ref.	Ø mín - máx	PVP 2023	Preço OFERTA
FZT51310	4,5 - 9,5	89,70	85,43

JOGO DE MACHOS
QUADRADOS HELICOIDAIS

JOGO EXTRADORES COM
ROLOS



WWW.FORZA.ES

I.V.A. NÃO INCLUIDO / CAMPANHA VÁLIDA ATÉ 31 DE DEZEMBRO DE 2023





FERRAMENTAS DE INSPEÇÃO

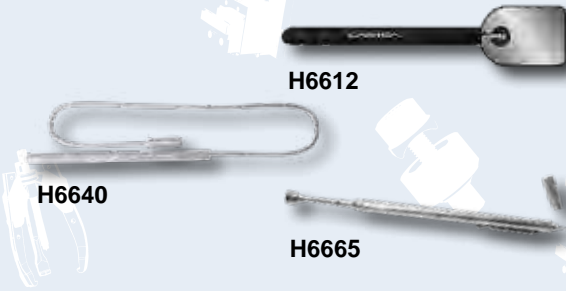

Ref.	Medidas	PVP 2023	Preço OFERTA
FZH6612	Espelho 45x60mm	17,90	17,05
FZH6640	Imán flex. 552mm.	12,40	11,81
FZH6665	Caneta imán 160-475mm.	17,20	16,38

GRAMPO DE GRANDE APERTO



FORÇA MÁXIMA: 9.000N

Ref.	A x B	PVP 2023	Preço OFERTA
FZP40200	200 x 120	29,70	28,29
FZP40300	300 x 120	32,90	31,33
FZP40400	400 x 120	35,80	34,10
FZP40600	600 x 120	41,60	39,62

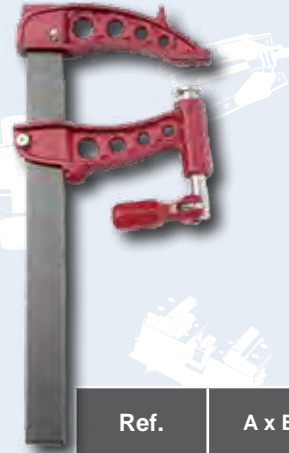

Sistema de êmbolo
Freio antideslizante
Lubrificado
A Pega ergonómica

Ref.	A x B	PVP 2023	Preço OFERTA
FZP60040	400 x 120	42,60	40,57
FZP60060	600 x 120	49,60	47,24

GRAMPO PROFSSIONAL

GRAMPO DE AÇÃO RÁPIDA

Força máxima 1500N
Cabeças de nylon e fibra de vidro
Barra de aço carbono carbono temperada.
Reversível

Ref.	A x B	PVP 2023	Preço OFERTA
FZP52615	150 x 80	27,30	26,00
FZP52630	300 x 90	30,50	29,05
FZP52645	450 x 100	32,40	30,86
FZP52660	600 x 110	34,20	32,57

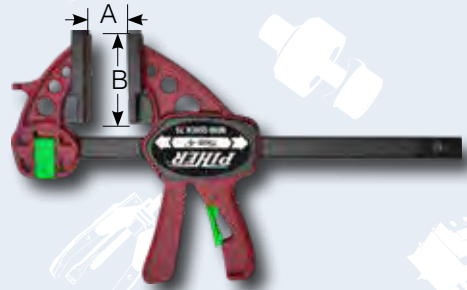

ESCORAS



RESISTENTE A A OXIDAÇÃO

Sapata antideslizante adaptável a diferentes ângulos.
Fabricado em tubo de aço de 1 mm de espessura.
Nylon reforçado com fibra de vidro.
Regulação do esforço com um fio.

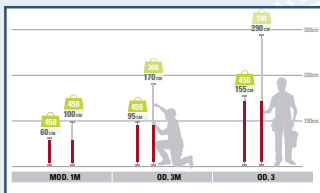

Hasta 450 KG

Ref.	Medidas	PVP 2023	Preço OFERTA
FZP30010	600-1000mm	44,10	41,68
FZP30011	950-1700mm	49,80	47,11
FZP30012	1550-2900mm.	54,10	51,12

Elimina corrimientos de carga.

Facilita el ajuste de trabajos de expansión.

Sujeción y nivelación de trabajos.

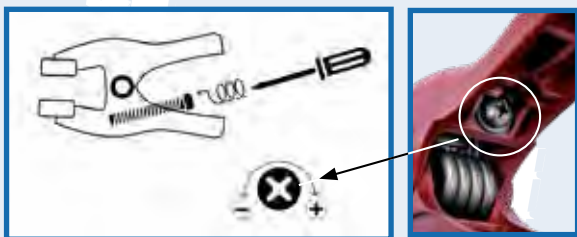

- Pressão ajustável com parafuso.
- Corpo em nylon e fibra de vidro.

- Grampo de ângulo ajustável.
- Mola endurecida extra forte



Ref.	mm.	mm.	PVP 2023	Preço OFERTA
FZP30910	30 x 35 (115mm)		4,80	4,57



Uso industrial
Para soldar

- Ímã de ferrite protegido com baquelite resistente a altas temperaturas.
- Ângulos de 45° e 90°.
- Chapas de aço de 2,5 mm unidas com parafusos roscados.

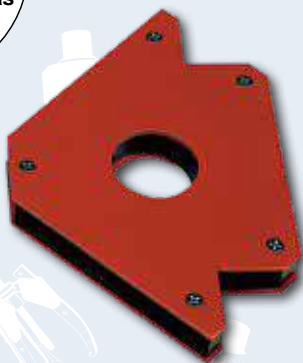
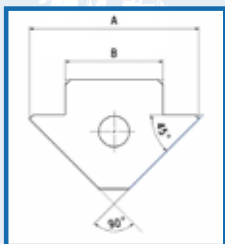

Ref.	A x B	PVP 2023	Preço OFERTA
FZP29003	120 x 70	14,80	14,10
FZP29004	159,5 x 92	23,60	22,48
FZP29005	201 x 125	38,40	36,57



PEGA REFORÇADA

Ref.	FORÇA MÁX.	PVP 2023	Preço OFERTA
FZP56003	2500Nm - 250K	39,20	37,33
FZP56004	3400Nm - 340K	50,80	48,38

Ref.	FORÇA MÁX.	PVP 2023	Preço OFERTA
FZP56051	700Nm - 70K	29,50	28,10
FZP56052	900Nm - 90K	33,00	31,43
FZP56053	2200Nm - 220K	40,30	38,68



Muito fácil a passagem de interior para exterior movendo apenas uma alavanca.

Com pontas intercambiáveis interiores e exteriores. Cada alicate inclui 3 jogos de pontas retas e 3 jogos de pontas curvas.

Ref.	Medidas	PVP 2023	Preço OFERTA
FZ5830N	Alicate Seguer ext. 3/26 - int. 7/26	52,10	49,62
FZ5840N	Alicate Seguer ext. 7/51 - int. 10/51	59,10	56,29



FZ5800N: Jogo com 3 modelos (12 x 3) = 36 alicates diferentes

Ref.	Contem	PVP 2023	Preço OFERTA
FZ5800N	5830N, 5840N, 5860N	259,90	247,52

FZ5800S: Juego con 2 modelos (12 x 2) = 24 alicates diferentes

Ref.	Contem	PVP 2023	Preço OFERTA
FZ5800S	5830N, 5840N	137,90	131,33



PERFURADORES DE CHAPA REDONDOS MECÂNICOS

Perfuradores corrigidos. Resistência de parafuso 150Kg/mm²



Capacidade de corte 2 mm em chapa de aço, 1,2 em inoxidável.

Ref.	Medidas	PVP 2023	Preço OFERTA
FZ54/16	Ø16 mm.	32,50	24,14
FZ54/18	Ø18 mm.	35,40	26,30
FZ54/20	Ø20 mm.	40,50	30,09
FZ54/22	Ø22 mm.	40,50	30,09
FZ54/25	Ø25 mm.	47,10	34,99
FZ54/28	Ø28 mm.	54,90	40,78
FZ54/30	Ø30 mm.	54,90	40,78
FZ54/32	Ø32 mm.	54,90	40,78
FZ54/35	Ø35 mm.	61,30	45,54
FZ54/37	Ø37 mm.	61,30	45,54
FZ54/40	Ø40 mm.	68,70	51,03

Capacidade de corte: 2 mm em capa de aço (1,2mm em inoxidável)



Perfuradores fresados.

Ref.	Medidas	PVP 2023	Preço OFERTA
FZ54VAL16	Ø16 mm.	21,50	15,97
FZ54VAL18	Ø18 mm.	23,30	17,31
FZ54VAL20	Ø20 mm.	24,40	18,13
FZ54VAL22	Ø22 mm.	26,50	19,69
FZ54VAL25	Ø25 mm.	29,30	21,77
FZ54VAL28	Ø28 mm.	32,30	23,99
FZ54VAL30	Ø30 mm.	32,10	23,85
FZ54VAL32	Ø32 mm.	33,00	24,51
FZ54VAL35	Ø35 mm.	36,80	27,34
FZ54VAL37	Ø37 mm.	37,00	27,49
FZ54VAL40	Ø40 mm.	50,00	37,14

PERFURADORES DE CHAPA REDONDOS
MECÂNICOS

NOVIDADE



**COM MAIS
CAPACIDADE
DE CORTE**

**3 mm
em chapa de aço
2 mm
em inox.**

Perfuradores fresados

Ref.	Medidas	PVP 2023	Preço OFERTA
56/16	Ø16 mm.	47,20	35,06
56/18	Ø18 mm.	49,80	36,99
56/20	Ø20 mm.	53,80	39,97
56/22	Ø22 mm.	53,80	39,97
56/25	Ø25 mm.	58,70	43,61
56/28	Ø28 mm.	70,00	52,00
56/30	Ø30 mm.	70,30	52,22
56/32	Ø32 mm.	70,30	52,22
56/35	Ø35 mm.	77,80	57,79
56/37	Ø37 mm.	77,80	57,79
56/40	Ø40 mm.	87,10	64,70
56/45	Ø45 mm.	93,90	69,75
56/47	Ø47 mm.	98,70	73,32
56/50	Ø50 mm.	99,10	73,62
56/55	Ø55 mm.	151,00	112,17
56/60	Ø60 mm.	177,60	131,93
56/63	Ø63 mm.	195,70	145,38

Capacidade de corte:
2 mm em chapa de aço
1,2 mm em inox.

Perfuradores retificados.
Resistência do parafuso
150Kg/mm²



Ref.	Medidas	PVP 2023	Preço OFERTA
54J43	Ø 18 - 22 - 25 - 32	137,90	131,33



**JOGO DE PERFURADORES
DE CHAPA VALLCIA**

PRENSA HIDRÁULICA 8Tn



O retorno do êmbolo tem de ser feito manualmente.

Ref.	Descrição	PVP 2023	Preço OFERTA
FZ2660	pressa hidr. 8Tm	149,90	111,35

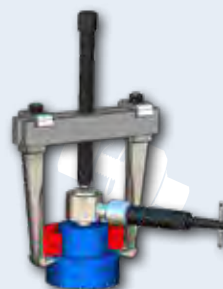

WWW.FORZA.ES

I.V.A. NÃO INCLUIDO / CAMPANHA VÁLIDA ATÉ 31 DE DEZEMBRO DE 2023





WWW.FORZA.ES

I.V.A. NÃO INCLUIDO / CAMPANHA VÁLIDA ATÉ 31 DE DEZEMBRO DE 2023

FORZA®



Ferramentas projetadas para fazer furos em folhas de borracha, feltro, papelão, metais leves, etc.

O suporte permite montar duas fresas ao mesmo tempo para fabricar anilhas e juntas especiais.

**NOVO
PRODUTO**



**82,71
euros**

FZ86320M
PVP **96,50 euros**

Sacabocados intercambiáveis de
Ø 3-4-6-8-10-12-14-16-18-20 mm.



**150,00
euros**

FZ86330M
PVP **175 euros**

Sacabocados intercambiáveis com pega
ergonómica reforçada Ø 3-4-6-8-10-12-14-
16-18-20-22-24-26-28-30mm.



**175,71
euros**

FZ86330MC
PVP **205 euros**

Sacabocados intercambiáveis com pega
ergonómica reforçada Ø 3-4-6-8-10-12-14-
16-18-20-22-24-26-28-30 mm + ponta de
centrado retráctil + compás 330mm.



**510,86
euros**

FZ86250M
PVP **596 euros**

Sacabocados intercambiáveis com pega
ergonómica reforçada Ø 2-3-4-5-6-7-8-9-
10-12-14-16-18-20-22-24-26-28-30-32-
34-36-38-40-42-44-46-48-50 mm.



**NOVO
PRODUTO**

**34,29
euros**

**FZ87100E
PVP 40 euros**

Standard metálico Ø 3-4-5-6-8 mm.

Os **ponteiros cilíndricos** têm uma ponta larga e são regularmente utilizados para empurrar pinos ou peças tais como parafusos em espaços limitados pelo tamanho do orifício. São utilizados em toda a indústria para marcação, ajuste ou movimentação de peças em geral. Como ferramenta de impacto, podem ajudar em muitas situações em que as peças ficam presas e não há forma de as deslocar.

Ref.	Comprimento	Corpo	Lâmina	Altura	PVP 2023	Preço OFERTA
FZ871003B	150	10	3	82	6,65	5,70
FZ871004B	150	10	4	84	6,65	5,70
FZ871005B	150	10	5	86	6,65	5,70
FZ871006B	150	10	6	88	6,65	5,70
FZ871008B	150	12	8	123	7,65	6,56

Ponteiros **sem pega**

Ref.	Descrição	PVP 2023	Preço OFERTA
FZ87200C	Caixa de ponteiros sem pega	29,50	25,29
FZ87200E	Expositor de ponteiros sem pega	31,25	26,79



Ref.	Comprimento	Corpo	Lâmina	Altura	PVP 2023	Preço OFERTA
FZ872003B	150	10	3	70	4,15	3,56
FZ872004B	150	10	4	72	4,15	3,56
FZ872005B	150	10	5	72	4,15	3,56
FZ872006B	150	10	6	72	4,15	3,56
FZ872008B	150	12	8	102	4,80	4,11
FZ872010B	150	12	10	120	4,80	4,11

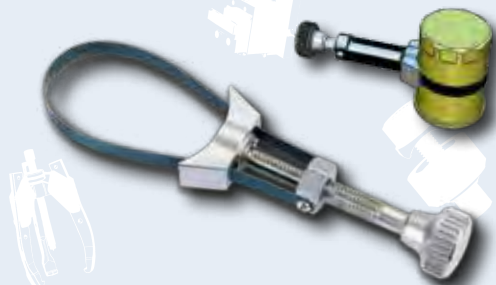

PONTEIROS

CHAVE DE FILTROS
DE ÓLEO de cinta

Esta chave é muito conveniente para montagem e desmontagem de filtros em espaços confinados.

Ref.	Medidas	PVP 2023	Preço OFERTA
FZ5002	Ø65-110mm	15,80	11,74
FZ500238	cinta 5002	2,60	1,93
FZ5003	Ø110-155mm	17,90	13,30
FZ500338	cinta 5003	3,80	2,82

CHAVE DE FILTROS DE ÓLEO
DE GARRA

*Para cabo e chave

Ref.	Medidas	PVP 2023	Preço OFERTA
FZ5000	Ø55-72	77,10	57,27
FZ5001*	Ø68-110	108,10	80,30
FZ5001G*	Ø110-142	206,70	153,55

Punho com efeito de alavanca

Ref.	Medidas	PVP 2023	Preço OFERTA
FZ015500	Ø279 mm.	55,90	53,24

CHAVE DE FILTROS DE CORREIA

ALAVANCA REMOVÍVEL
PARA PNEUS

Ref.	Medidas	PVP 2023	Preço OFERTA
RUD120	Alavanca removível que melhora a desmontagem dos pneus. Não arrase as jantes	41,50	39,52

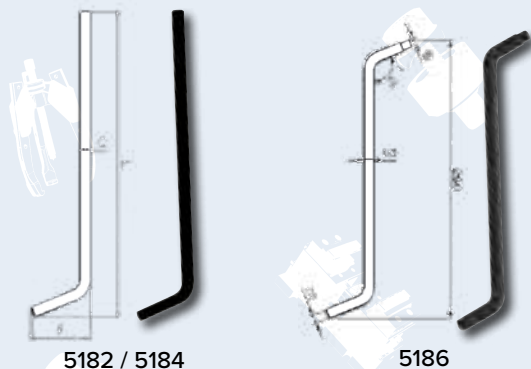
CHAVES QUADRADAS PARA
TAMPÕES DE ÓLEO

Ref.	A x L x C	PVP 2023	Preço OFERTA
FZ5182	48 x 221 x 8	9,00	6,69
FZ5184	50 x 241 x 10	10,00	7,43
FZ5186	Combinado 8 e 10	16,20	12,04



Ref.	Medidas	PVP 2023	Preço OFERTA
FZ5198	Ø34 a Ø72	685,00	508,86

EXTRATOR DE SILENT-BLOCKS

EXTRATOR DE
RÓTULAS 2 POSIÇÕES

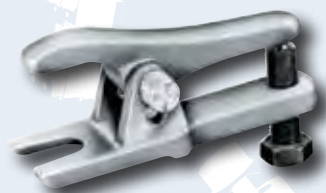

Ref.	A / Ø	PVP 2023	Preço OFERTA
FZ5691	56 / 20-24	101,20	75,18



Ref.	Medidas	PVP 2023	Preço OFERTA
FZ5681	50 / 18-22	65,20	48,43
FZ5683	95 / 28-32	139,00	103,26

EXTRATOR DE
RÓTULAS ACCÇÃO DIRECTA

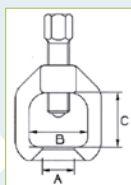

Extrator de ação directa



Ref.	A x B x C	PVP 2023	Preço OFERTA
FZ5651	18 x 40 x 35	40,60	30,16
FZ5652	25 x 50 x 45	47,50	35,29
FZ5653	29 x 60 x 55	68,40	50,81
FZ5654	40 x 80 x 80	88,50	65,75
FZ5655	58 x 80 x 80	123,70	91,89
FZ5656	46 x 90 x 100	135,30	100,51



Permite a substituição de juntas esféricas axiais ou tirantes de direcção sem desmontar a cremalheira e o pinhão. Rápido e eficiente.

Ref.	Medidas	PVP 2023	Preço OFERTA
FZ5660	Ø int. 41mm Long. 85mm	72,30	53,71

EXTRATOR DE
RÓTULAS DE CAMIÃO

NOVO
PRODUTO

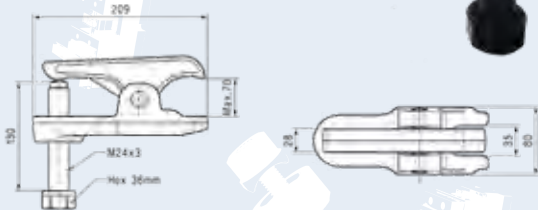

Extrator mecânico de rótulas universal para camiões.

Fabricado em aço forjado F125 com um acabamento niquelado. O passador e o fuso são feitos de aço temperado 45HRc, o que torna este novo modelo mais robusto.

Ref.	Ø	A	PVP 2023	Preço OFERTA
FZ5695	36	70	178,00	132,23

Novos modelos para cortar e soltar porcas. Melhorado com um suporte que facilita o corte da porca. Lâmina perpendicular à face da porca. Afição da lâmina a 60 graus assegura o corte mais suave. Lâminas de substituição disponíveis.



Ref.	Medidas	PVP 2023	Preço OFERTA
FZ6311	M14 x 1,5 x 47	56,80	42,19
FZ6312	M14 x 1,5 x 47	66,90	49,70
FZ6313	M18 x 1,5 x 50	97,50	72,43

NOVO
DESIGN



EXTRATOR DE
RÓTULAS UNIVERSAL

EXTRATOR DE
RÓTULAS AXIAIS

CORTA PORCAS



WWW.FORZA.ES

I.V.A. NÃO INCLUIDO / CAMPANHA VÁLIDA ATÉ 31 DE DEZEMBRO DE 2023

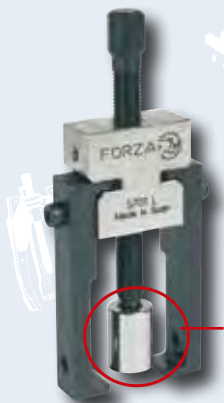

EXTRATOR DE
LIMPA - PARABRISAS

Para aplicações onde o eixo coincide com o esguicho da água do limpa-parabrisas

Ref.	Medida	PVP 2023	Preço OFERTA
FZ5701L	abert. 28mm	52,30	38,85

DESMONTADOR E
MONTADOR DE CORREIAS

Ref.	PVP 2023	Preço OFERTA
FZ5110	224,00	166,40

Desmontar correias até 1"
Rebitar correias até 3/4"

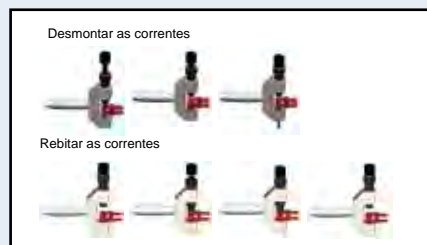

JOGO EXTRATOR DE PRATOS MAGNÉTICOS



Ref.	R	PVP 2023	Preço OFERTA
FZ5216	M16X100	28,00	20,80
FZ5219	M19X100	27,90	20,73
FZ5223-15	M23X150	29,10	21,62
FZ5224-1	M24X100	29,10	21,62
FZ5226-1	M26X100	30,10	22,36
FZ5227	M27X125	30,10	22,36
FZ5227-1	M27X100	30,10	22,36
FZ5227-1iz	M27X150	30,60	22,73

JOGO FZ5200A	198,60	147,53
--------------	--------	--------

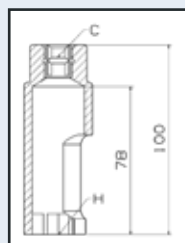

Contém:

- Chave hexagonal de 10 mm com furo
- 4 adaptadores masculinos de M17 a M27
- 2 adaptadores femininos de M14 e M27
- 1 Adaptador extrator de anilhas
- 4 chaves hexagonais com ranhura de 25 a 30 mm.
- FZ4394 - Barra de impacto de 2kg

Ref.	Descrição	PVP 2023	Preço OFERTA
FZ5156	Jogo Universal	395,00	293,43

DESPOLIDOR DE CILINDROS
DE VEÍCULOS

Ref.	Medida	PVP 2023	Preço OFERTA
FZ028100	Despolidor 50 a 180mm	67,90	64,67

Pedras de substituição

FZ028101	fina 400	24,50	23,33
FZ028102	media 220	30,50	29,05
FZ028103	gruesa 100	30,20	28,76