

PROMOÇÃO

• Enjoyment

• Health

• Innovation

• Quality

KING TONY



2023/24







ORGANIZAÇÃO ORIENTADA A OBJETOS

Composição 01 - Mobiliário oficina balcão Inox

Medidas : 4885 x 460 x 2000 mm

462.23 KG CUFT 116.75



5237.00€

87D11X01SA-KG



5237.00€

87D11X01SA-KB





ORGANIZAÇÃO ORIENTADA A OBJETOS

Composição 04 - Mobiliário oficina balcão madeira

2819.00€

87D11X04A-KG



2819.00€

87D11X04A-KB



Medidas : 2640 x 460 x 2000 mm

⚖️ 248.60 CUFT 64.91



Composição 05 - Mobiliário oficina balcão madeira

2186.00€

87D11X05A-KG



2186.00€

87D11X05A-KB



Medidas : 2275 x 460 x 2000 mm

⚖️ 202.50 CUFT 51.83

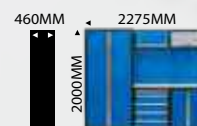

Armário superior com porta

150.00€

87D11-01A-KG



150.00€

87D11-01A-KB



Armário superior com persiana

130.00€

87D11-17A-KG



130.00€

87D11-17A-KB



REF ^o	Medidas (mm)		CUFT
87D11-01A-KG	680 x 280 x 350	10.0	3.73
87D11-01A-KB			
87D11-17A-KG		8.4	
87D11-17A-KB			



Armário duplo

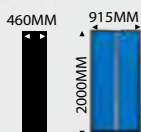

767.00€

87D11-18A-KG



767.00€

87D11-18A-KB



Armário simples

554.00€

87D11-02A-KG



554.00€

87D11-02A-KB



REF ^o	Medidas (mm)		CUFT
87D11-18A-KG	915 x 460 x 2000	78	12.72
87D11-18A-KB			

REF ^o	Medidas (mm)		CUFT
87D11-02A-KG	600 x 460 x 2000	53	9.28
87D11-02A-KB			



Módulo duas portas

278.00€

87D11-03A-KG

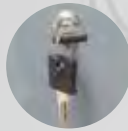

278.00€

87D11-03A-KB



REFª	Medidas (mm)	Kg	CUFT
87D11-03A-KG	680 x 460 x 910	28.5	13.58
87D11-03A-KB			

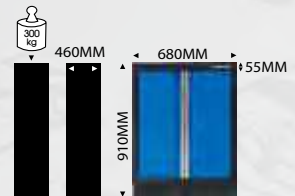

Módulo 4 gavetas

444.00€

87D11-04A-KG



444.00€

87D11-04A-KB



475.00€

87D11-05A-KG



475.00€

87D11-05A-KB

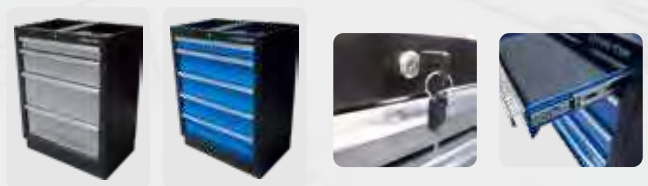
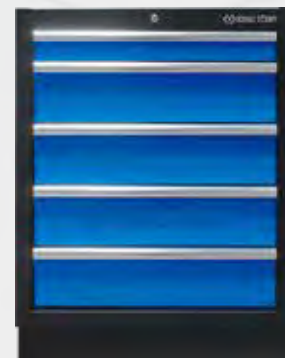

REFª	Especif.	Medidas (mm)	Kg	CUFT
87D11-04A-KG	4 Gavetas	680 x 460 x 910	46.70	13.58
87D11-04A-KB				
87D11-05A-KG	5 Gavetas		49.30	
87D11-05A-KB				

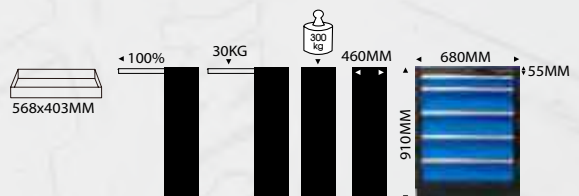

Pilar de ligação

87D11-07

REF ^e	Medidas (mm)		CUFT	€
87D11-07A-G	66 x 30 x 1420	2	0.24	23.00
87D11-07A-B				23.00
87D11-071A-G	33 x 30 x 1420	1.5	0.15	18.00
87D11-071A-B				18.00

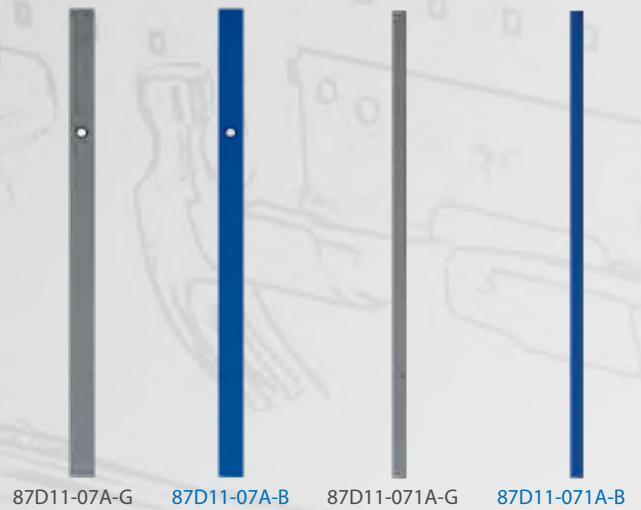

ACESSÓRIOS OPCIONAIS

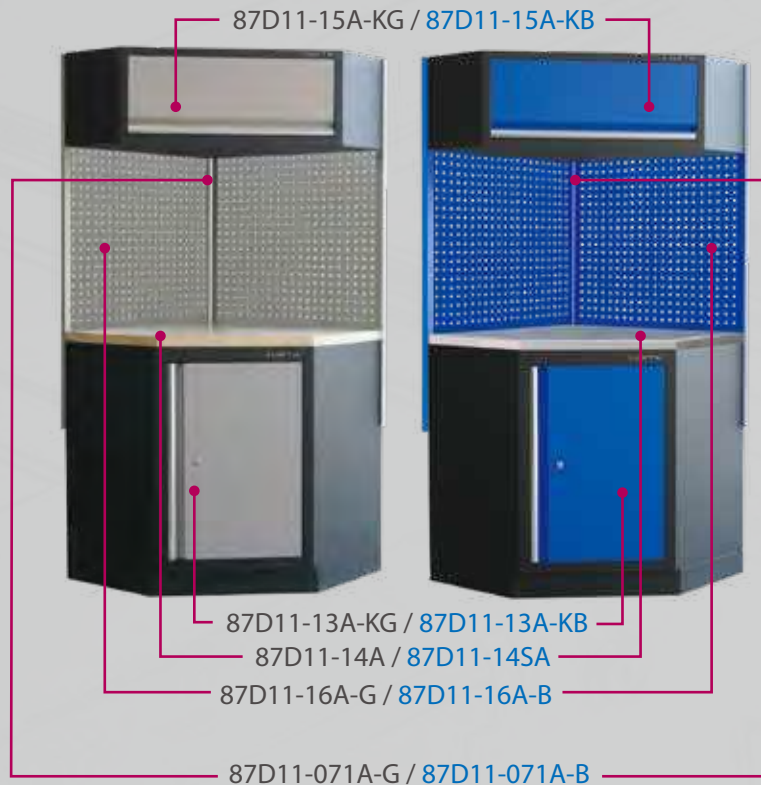

Painel traseiro para módulo de canto

83.00€
87D11-16A-G

83.00€
87D11-16A-B

REF ^e	Medidas (mm)		CUFT
87D11-16A-G	800 x 25 x 1052	6.95	1.45
87D11-16A-B			



Tampo de inox para módulo de canto



266.00€
87D11-14SA



REFª	Medidas (mm)		CUFT
87D11-14SA	865 x 865 x 38	19	1.94

Tampo de madeira para módulo de canto



180.00€
87D11-14A



KT NO.	Medidas (mm)		CUFT
87D11-14A	865 x 865 x 38	13	1.94

Armário superior canto com porta

273.00€
87D11-15A-KG



REFª	Medidas (mm)		CUFT
87D11-15A-KG	865 x 865 x 350	21	12.70
87D11-15A-KB			

273.00€
87D11-15A-KB



Módulo de canto com porta

477.00€
87D11-13A-KG



REFª	Medidas (mm)		CUFT
87D11-13A-KG	865 x 865 x 910	42	7.06
87D11-13A-KB			

477.00€
87D11-13A-KB

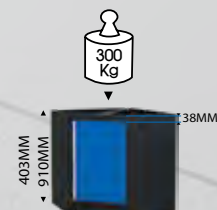
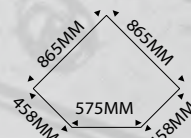

87D11-20A-K
87D11-20LA-K

87D11-22A-KG
87D11-22A-KB

87D11-21A-KG
87D11-21A-KB

87D11-26A-K

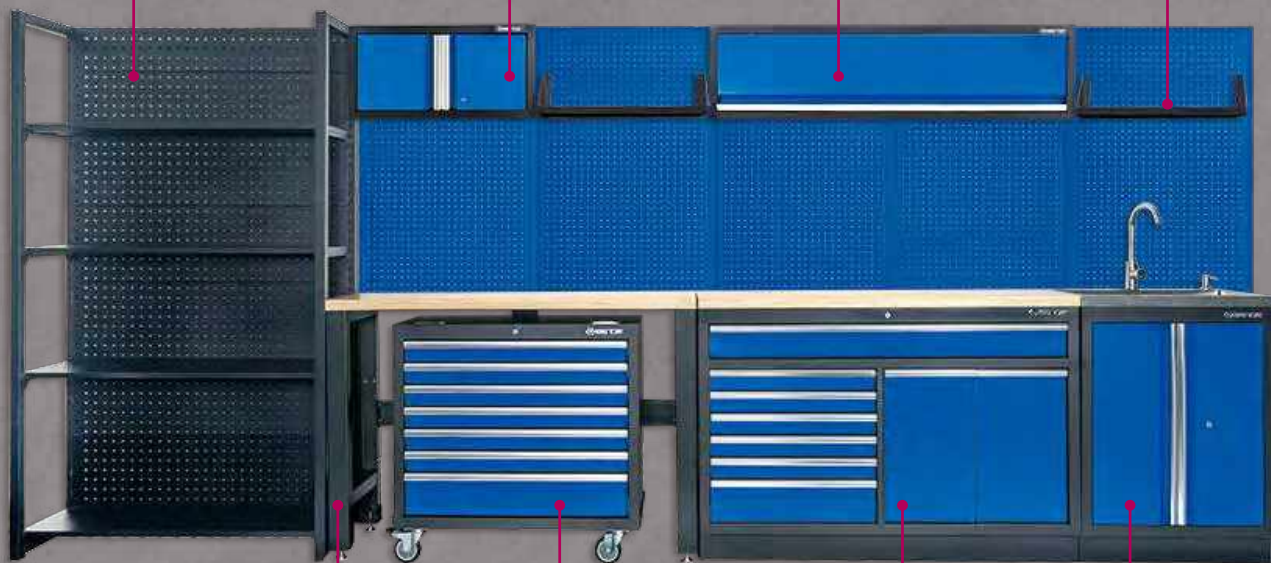

87D11-24A-K

87D11-25A-KG
87D11-25A-KB

87D11-23A-KG
87D11-23A-KB

87D11-19A-KG
87D11-19A-KB

Armário superior duplo com porta

256.00€

87D11-21A-KG



256.00€

87D11-21A-KB



REF ^o	Medidas (mm)	Kg	CUFT
87D11-21A-KG	1360 x 281 x 350	17	7.24
87D11-21A-KB			

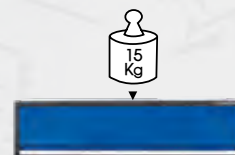

Armário superior com porta dupla

152.00€

87D11-22A-KG



152.00€

87D11-22A-KB



REF ^o	Medidas (mm)	Kg	CUFT
87D11-22A-KG	680 x 281 x 350	9	3.72
87D11-22A-KB			

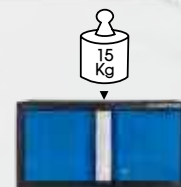

Módulo com banca de lavagem e torneira água

896.00€
87D11-19A-KG



Recipiente para sabonete

896.00€
87D11-19A-KB



REFª	Medidas (mm)	Kg	CUFT
87D11-19A-KG	680 x 464 x 948	33	14.23
87D11-19A-KB			

Modulo 9 gavetas para arrumação de ferramentas e peças

1236.00€
87D11-23A-KG



1236.00€
87D11-23A-KB



• Caixa de armazenamento • Lata de lixo



• Mecanismo de segurança

REFª	Especif.	Medidas (mm)	Kg	CUFT
87D11-23A-KG 87D11-23A-KB	Medidas	1360 x 730 x 725	112	29.77
	1 Gavetas	1272 x 403 x 84		
	5 Gavetas	783 x 403 x 58		
	1 Gavetas	783 x 403 x 137		
	2 door	284 x 371 x 531		



Estrutura bancada de trabalho

- A estrutura da bancada pode ser combinada com o armário de ferramentas 87D11-25A-KG
- Adequado para uso com mesa de bancada (87D11-08A)

191.00€

87D11-24A-K

A mesa de bancada não está incluída ✕

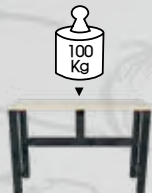

REFª	Medidas (mm)	Kg	CUFT
87D11-24A-K	1361 x 458 x 895	19,5	4,22

Carro para ferramentas 7 gavetas (XL)

- Adequado para uso com bancada 87D11-24A-K
- Gavetas de 35" de largura, aumentando o espaço de armazenamento
- Quatro rodízios giratórios (um com mecanismo de freio)

771.00€

87D11-25A-KG



771.00€

87D11-25A-KB



- O design da ranhura é fácil de retirar

350 Kg



REFª	Especif.	Medidas (mm)	Kg	CUFT
87D11-25A-KG	1 Gavetas	785 x 403 x 137	65	14,07
87D11-25A-KB	6 Gavetas	785 x 403 x 58		

Prateleiras de arrumação

- Multi-camada de armazenamento
- Adequado para combinar com o sistema de armário de ferramentas 87D11



REF ^o	Medidas (mm)		CUFT
87D11-20A-K	680 x 458 x 2000	41	5.94
87D11-20LA-K	1200 x 458 x 2000	55	5.94

316.00€

87D11-20A-K

417.00€

87D11-20LA-K



Parteleira para painéis traseiros

- Bandeja de parede para painel traseiro, fácil de guardar



39.00€

87D11-26A-K



REF ^o	Medidas (mm)			CUFT
87D11-26A-K	602 x 281 x 178	2.6	1 / 4	1.71



Mala de mão à prova de impactos com divisões para pequenas peças

- Estojo de plástico resistente com espuma interna acolchoada
- Poliestireno de alto impacto com 12 divisórias internas
- Facial acondicionamento e transporte das peças
- Mini estojo (278 x 87 x 42 mm)



42.00€
827011

Ø Estojo (mm):
422 x 372 x 92 (0.51 Cuft)

REF ^o	Conteúdo		
827011	84700011B x4	2.19	1 / 4

Caixa organizadora com compartimentos ajustáveis

- O compartimento ajustável é adequado para organizar diferentes tamanhos de peças e acessórios
- A tampa transparente facilita a localização das peças de que precisa
- A caixa é design empilhável, pode combinar duas caixas facilmente
- Material resistente, fácil de transportar



14.00€
8714101B

- Compartimento ajustável
- Adequado para organizar peças e acessórios



- Deslize para bloquear



- Design empilhável



REF ^o	Tam. mm		
8714101B	376 x 290 x 67	790	1 / 16

Mochila porta ferramentas 14 compartimentos

- Material: Poliéster 600D
- Carga Máxima: 20kg
- Inclui 14 bolsos

1.6

86.00€
87723B

As almofadas na parte de trás do produto podem absorver vibrações e aumentar a respirabilidade, tornando-o mais confortável de transportar



A mochila tem uma base de PVC à prova d'água e resistente ao desgaste



A bolsa principal tem grande capacidade para facilitar o acesso às ferramentas com bolsos para várias ferramentas dentro da mochila

Product Dimensions :
49 x 35 x 21(cm)



• As alças robustas e ergonômicas na tampa e na frente permitem ser transportadas de acordo com sua necessidade



• A bolsa de ferramentas de camada dupla pode ajustar o espaço através da fivela para facilitar o usuário a pegar nas ferramentas

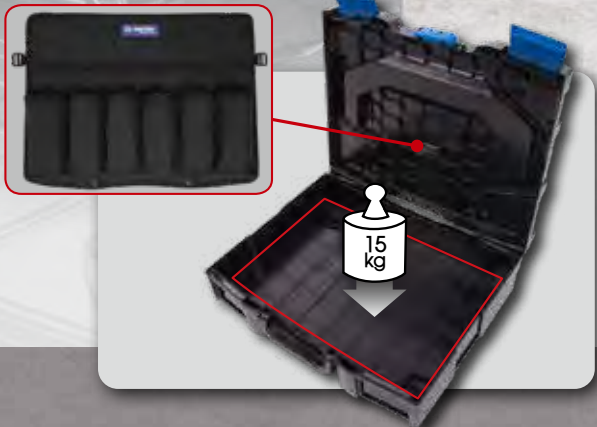

Para maior clareza, pode anexar etiquetas na frente ou nas laterais da caixa para otimizar o fluxo de trabalho

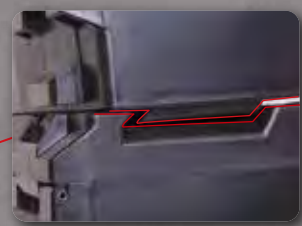

• Fecho rotativo de 90° também é extremamente prático, pois pode abri-lo com apenas uma mão



• Fixação de caixas na base



• Com quatro rodízios giratórios dos quais dois são travados por um freio integrado

Jogo ferramentas p/ electricista em caixa modular

500.00€

9052-001MRV

37
PC.



Bolsa 1

6
PC.



Bolsa 2

21
PC.



Espuma EVA

10
PC.



Ø Cx plástica (mm):
456 x 372 x 155 (0.93 cuft)

8.69 CUFT 1.16



Jogo ferramentas "indispensáveis" em caixa modular

429.00€

9052-002MRV

112
PC.



Bolsa 1

13
PC.



Bolsa 2

7
PC.



Espuma EVA

92
PC.



Ø Cx plástica (mm):
456 x 372 x 155 (0.93 cuft)

10.46 CUFT 1.16



Caixa PVC com ferramentas eletricista

•Para equipamentos de eletricista

225.00€
97121PQ

21 PC.



87407
Medidas :
445 x 240 x 206 mm

Conteúdo		kg 4.9	1	CUFT0.79
⊕	1471	VDE PH0 x 75, PH1 x 100, PH2 x 100, PH3 x 150		
⊖	1472	VDE 3 x 75, 4 x 100, 5.5 x 125, 6.5 x 150, 8 x 175		
	6116-07A	VDE 7-1/2"		
	6146-08A	VDE 8-1/4"		
	6216-06A	VDE 6-1/2"		
	6318-08A	VDE 8-1/4"		
	6516-10A	VDE 10"		
	6716-06A	VDE 6-1/4"		
	6214-45	4-1/2"		
	6334-05	5"		
	6721-10			
	6751-44			
	6AB12-55			
	7932-04			

Báu 6 gavetas com 219 ferramentas

1192.00€
911-000CR



9-7069CR #1



9-90129CR #3



9-90138CR #3



87411-6B



9-2548CR #2



9-42114GP #2



9-40102GP #2



9-90128SR #3

Caixa de ferramentas com 3 secções dobráveis

- Caixa 87402:
5 compartimentos 470 x 220 x 260 mm
- Caixa 87408:
5 compartimentos 530 x 220 x 260 mm



74.00€
87402

99.00€
87408

Armazenamento de Ferramentas e conjuntos de Ferramentas



REF ^o	Esp.	Dimensões(mm) Larg. x Prof. x Alt.	Kg	CUFT
87402	5	470 x 220 x 260	5.60	1.22
87408	compartimentos	530 x 220 x 260	6.70	1.3

Baú de ferramentas sistema de fecho central



320.00€
87411-6B

Carro de ferramentas com 1 gaveta



255.00€
87441-1B

REF ^o	Esp.	Dimensões(mm) Larg. x Prof. x Alt.	Kg	CUFT
87411-6B	Total	660 x 307 x 374	25.40	3.97
	Top	646 x 290 x 60		
	3 Gavetas	170 x 275 x 50		
	2 gavetas	569 x 275 x 50		
	1 gaveta	569 x 275 x 75		

REF ^o	Esp.	Dimensões(mm) Larg. x Prof. x Alt.	Kg	CUFT
87441-1B	Total	716 x 410 x 750	23.2	2.7
	Total + 4" x 1-1/4" Rodízios	716 x 410 x 880		
	1 gaveta	569 x 275 x 75		



Bancada de trabalho

- Bancada de trabalho exclui placa de corte e suporte de ferramenta
- 3 gavetas com corredeira do rolamento
- 2 Armários de parede

881.00€

87502

REF ^o	Esp.	Dimensões(mm) Larg. x Prof. x Alt.		CUFT
87502	Total	1525 x 700 x 1520	86.00	13.4
	3 gavetas	660 x 307 x 251		
	2 gavetas	569 x 275 x 50		
	1 gaveta	569 x 275 x 75		
	Armário de parede	400 x 200 x 500		



Bancada de trabalho com armário de parede

- 3 Gavetas corredeira de rolamento de esferas
- 1 armário de parede

1573.00€

87512

REF ^o	Esp.	Dimensões(mm) Larg. x Prof. x Alt.		CUFT
87512	Total	1565 x 766 x 1403	130.10	21.19
	3 gavetas	668 x 313 x 270		
	2 gavetas	568 x 262 x 50		
	1 gaveta	568 x 262 x 75		
	Armário de parede	1565 x 203 x 603		



Carro de ferramentas com 7 gavetas reversíveis + 5"

- Pára-choques macios de cada lado evitam arranhões ou danos ao veículo
- Mais espaço para pendurar garrafas
- Fácil movimentação lateral com rodízios industriais TPR
- Saída da gaveta a 100% com rolamento de esferas
- Estrutura em aço de peça única para estrutura de carga pesada
- Sistema de travamento central + tapete superior de 10mm

819.00€

87634-7B

819.00€

87634-7B-B

819.00€

87634-7B-G



REF ^o	Esp.	Dimensões(mm) Larg. x Prof. x Alt.	Rodízios	Carga est.		CUFT
87634-7B	5 gavetas	576 x 380 x 75	5"x1-1/4"	360 Kg	59	15.64
	2 gavetas	576 x 380 x 154				

- 4 gavetas no baú superior + 7 gavetas no Carro de ferramentas
- Os pára-choques de proteção de canto ABS evitam danificar o veículo
- Gavetas 100% extraíveis com rolamento de esferas e sistema de retorno automático
- Lados de rolamento de esferas pesados, capacidade de 35kgs para cada uma
- Tampa superior do baú com barras hidráulicas
- Com bandeja lateral e lata para lixo
- Juntas soldadas internamente para maior durabilidade



Bau para ferramentas 4 gavetas com proteções ABS

528.00€
87G11-4B-BK



REF ^a	Esp.	Dimensões(mm) Larg. x Prof. x Alt.		CUFT
87G11-4B-BK	Medidas	824 x 467 x 499	41.5	9.72
	4 Gavetas	575 x 410 x 70		

Carro para ferramentas 7 gavetas com proteções ABS

962.00€
87G31-7B-BK



REF ^a	Esp.	Dimensões(mm) Larg. x Prof. x Alt.	Rodízios	Carga est.		CUFT
87G31-7B-BK	Medidas	824 x 485 x 884	5" x 2"	500 Kg	75.00	16.85
	Medidas + 4 Rodízios	824 x 485 x 1062				
	5 Gavetas	575 x 410 x 70				
	1 Gavetas	575 x 410 x 110				
	1 Gavetas	575 x 410 x 140				

Carro para ferramentas 7 gavetas

- Fechos de Gavetas Magnéticos
- Tampo de trabalho multifuncional
- Sistema de bloqueio lateral



• Tampo de trabalho multifuncional extra grosso, durável



• lata de lixo em gancho



• Pára-choques TPR de proteção de canto



• Rodízios TPR giratórios

787.00€
87G37-7BA-G

787.00€
87G37-7BA



REF ^a	Esp.	Dimensões(mm) Larg. x Prof. x Alt.	Rodízios	Carga est.		CUFT
87G37-7BA	Medidas	770 x 450 x 815	5" x 2"	420 Kg	47.5	11.70
	Medidas + 4 Rodízios	770 x 450 x 970				
	5 Gavetas	570 x 380 x 70				
	2 Gavetas	570 x 380 x 140				



Jogo para caixa de ferramentas

68 PC.

487.00€

902-068MR

15.9 CUFT 1.22



9-4116FR #14



9-4319MR01 #14

- 1060 8, 10, 11, 12, 13, 14, 15, 16, 17, 18, 19, 21, 22, 24
- 1120MR H1.5, H2, H2.5, H3, H4, H5, H6, H8, H10
- 1421 PH1 x 80, PH2 x 38, PH3 x 150
- 1422 5.5 x 100, 6.5 x 38, 8 x 175
- 6111-07 7911-12
- 6311-06 76217-06
- 6511-10 76223-08
- 3611-12P 76403-05
- 76104-05 76404-06
- 76104-05 76405-65
- 76104-05 76406-07
- 7821-30



87402



Carro de Ferramentas 173 PC.

1576.00€

9634-000MR01



1576.00€

9634-000MR01-B



-B

1576.00€

9634-000MR01-G



-G



9-4333MR



9-7540MR



9-1216MR01



9-1711MR



9-90131MR



9-31110MR



9-22108MR



9-22308PR



9-90103PVP



9-40207GP



1006PR



Jogos de ferram. com espuma EVA

327 PC.



9-9003MRV01 #6



9-6314MRV #6



9-99430MFV #6



9-30208MRV #9



9-1220MRV #9



9-42116GPV #9



9-6414MPV #9



9-40104GPV #10



9-40113GPV #10



9-4147PRV #10



9-90118PRV #10



9-10112MRV #7
9-4143FRV #7



9-1044CQV #10



9-21-20-07MRV #10

2808.00€
9634-019MRV

2808.00€
9634-019MRV-B

2808.00€
9634-019MRV-G



Carro de ferramentas

173
PC.

1539.00€
9G37-000MR01-G

1539.00€
9G37-000MR01



9-4333MR #4 84700612B P* 9-7540MR #4 9-1216MR01 #4 9-1711MR #4 9-90131MR #4 9-31110MR #4
84700612B P* 84700612B P*



9-22108MR #4 84700612B P* 9-22308PR #4 9-90103PP #4 9-40207GP #4 1006PR #4
84700612B P* 84700612B P*



Carro 7 gavetas com 187 ferramentas

187 PC.

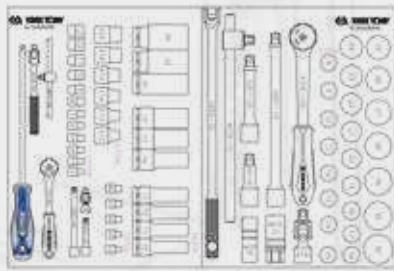

9-7540MRV #9

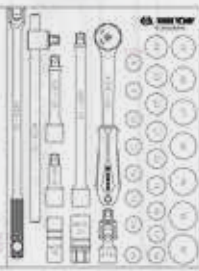

9-4333MRV #9



9-90131MRV #9



9-12D16MRV01 #9



9-1710MRV #9



9-1112MRV #9

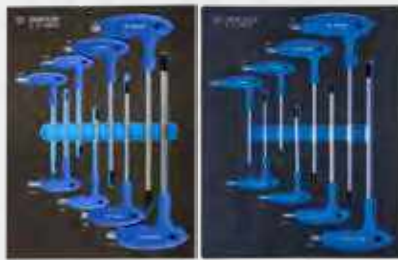

9-22108MRV #9



9-22308TRV #9

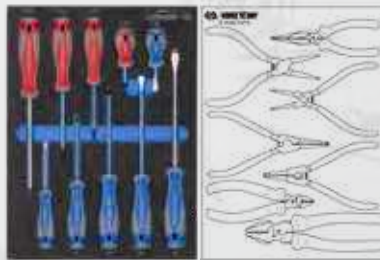

9-31110MRV #9



9-40207GPV #9

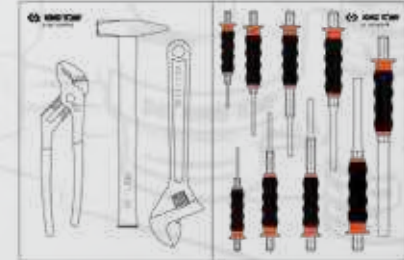

9-90103PPV #9



9-1009GPV #9

Carro 7 gavetas com 149 ferramentas

149 PC.



9-9003MRV01 #6



9-90217GRV #6



9-31110MRV #9



9-1219MRV01 #9



Roquetes & Acessórios

**Roquete reversível
1/4" (90 dentes)**



23.00€
2773-55GS

**Roquete reversível
1/2" (90 dentes)**



33.00€
4773-10GS

**1/4"DR. Roquete c/72
dentes cromado 5-1/2"**

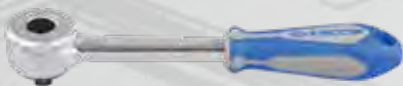

26.00€
2755-55G

3/8"DR. Roquete c/72 dentes



27.00€
3755-08G

**1/4"DR. Roquete
reversível 5-1/8" cromado**



20.00€
2779-55G

3/8"DR. Roquete reversível 8"



21.00€
3779-08G

**1/2"DR. Roquete
reversível c/72 dentes**



30.00€
4755-10G

1/2"DR. Roquete reversível 10"



27.00€
4779-10GR

**Roquete reversível
3/4" (24 dentes)**

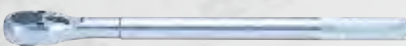

77.00€
6779-20F

**Roquete reversível 1"
(24 dentes)**



166.00€
8779-32F

Roquete reversível 3/4" (24 dentes) braço extensível

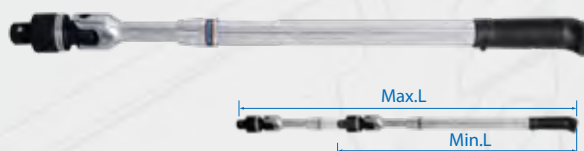

120.00€
6482-24G



Jogo chaves caixa 1/4" perfil sextavado interior (Metrico)

- Calha 130mmL
- Para parafuso sextavado
- H : 37mm
- Conjunto de broca de cabeça hexagonal: H3, H4, H5, H6, H7, H8, H10

11.50€
2127PR



7
PC.

Jogo chaves caixa 1/4" perfil sextavado interior (Polgadas)

- Calha 130mmL
- Para parafuso sextavado
- H : 37mm
- Broca Hexagonal: H1/8, H5/32, H3/16, H7/32, H1/4, H5/16, H3/8

10.00€
2127SR



7
PC.

Jogo chaves caixa 1/4" perfil torx

- Calha 150mmL
- Para parafuso de cabeça torx
- H : 37mm
- Chaves torx: T8, T9, T10, T15, T20, T25, T27, T30, T40

15.00€
2109PR



9
PC.

Jogo chaves caixa 1/2" perfil quadrado

- Calha 230mmL
- Chaves quadradas: RB8, RB9.5, RB10, RB10.5, RB12, RB12.7, RB13.5, RB19

30.00€
4118MR



8
PC.

Jogo chaves caixa 3/8" + 1/2" perfil E-Torx

- Calha 260mmL
- 3/8" DR. Chave estrela: E4, E5, E6, E7, E8, E11
- 1/2" DR. Chave estrela: E10, E12, E14, E16, E18, E20

35.00€
7113PR



12
PC.

Jogo chaves caixa 1/4" - 12PT

- Chave métrico profundo de 12PT: 4, 4.5, 5, 5.5, 6, 7, 8, 9, 10, 12, 13, 14
- Bit (cabeça TORX): T10, T15, T20, T25, T30, T40
- Bit (cabeça hexagonal): H3, H4, H5
- Bit (cabeça PHILLIPS): PH1, PH2
- Barra de extensão: 4"
- Porta-pontas magnético: 25 mm
- Roquete porta-brocas 72 dentes: 111 mm
- Junta universal: 36 mm

44.00€
2027MRE

27
PC.



Jogo chaves caixa 3/8" - 6PT

- Chave padrão métrico 6PT: 6, 7, 8, 9, 10, 11, 12, 13, 14, 15, 16, 17, 19, 21, 22, 23, 24
- Barra de extensão de deslocamento multifuncional: 3", 6"
- Cabo flexível: 205 mm
- Pega em T deslizante: 200 mm
- Roquete de libertação rápida e reversível de 32 dentes: 200 mm
- Junta universal: 50 mm



23
PC.

99.00€
3523MRV10



9 PC. 1/2"DR. Jogo de chaves de caixa com perfil torx

Ø Caixa de metal(mm) :
244 x 118 x 37 (0.038 cuft)

50.00€
4109PR

9
PC.



- T20, T25, T27, T30, T40, T45, T50, T55, T60

9 PC. 1/2"DR. Jogo de chaves de caixa com ponta 6PT 60mmL

Ø Caixa de metal(mm) :
198 x 105 x 32 (0.023 cuft)

47.00€
4110PR

9
PC.



- H3, H4, H5, H6, H7, H8, H10, H12, H14

4 PC. T-Jogo de desandador e chaves 19.21mm



40.00€
4503MR



26 PC. 1/4"DR. Jogo de chaves de caixa 6PT

Ø Caixa de metal(mm) :
244 x 118 x 37 (0.038 cuft)

53.00€
2526MR

26
PC.



- Chave : 4, 4.5, 5, 5.5, 6, 7, 8, 9, 10, 11, 13 mm
- Chave funda : 4, 5, 5.5, 6, 7, 8, 9, 10, 11, 13 mm
- Roquete reversível 24 dentes : 130 mm
- Barra extensão : 2", 4"
- Junta universal : 36 mm
- Adaptador 1/4"F x 3/8"M

Jogo chaves caixa 1/2" caixa metálica - 12PT

- 12PT Metric Standard Chave: 10, 11, 12, 13, 14, 15, 16, 17, 18, 19, 20, 21, 22, 23, 24, 27, 30, 32
- 32 Teeth Reversible Ratchet: 262 mm
- Sliding T-handle: 250 mm
- Speed Brace: 412 mm
- Extension Bar: 5", 10"
- Universal Joint: 77.5 mm
- Ø Cx metálica (mm): 445 x 187 x 50 (0.147 cuft)

121.00€
4225MR

24
PC.



Jogo chaves caixa 1/2" + Roquete telescópico

- Chave padrão métrico 6PT: 8, 10, 11, 12, 13, 14, 15, 16, 17, 18, 19, 21, 22, 23, 24, 27, 28, 30, 32
 - Barra de extensão: 5", 10"
 - Junta universal: 59 mm
 - Pega em T deslizante: 300 mm
 - Chave de catraca telescópica: 365~550 mm
- Ø Cx plástica (mm):
389 x 230 x 66 (0.208 Cuft)

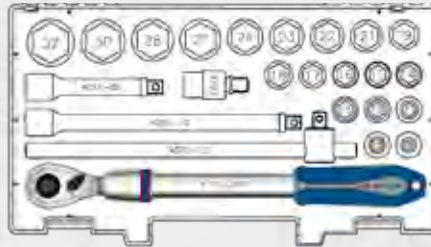

24
PC.

218.00€
4524MRV04

Design de linha assimétrica

Ø Cx plástica (mm):
170 x 95 x 51 (0.029 cuft)

39
PC.

PAT.

84.00€
2539MR-AM



• Mecanismo de pressão



• Rack de bits de elevação automática



• Fácil de pegar

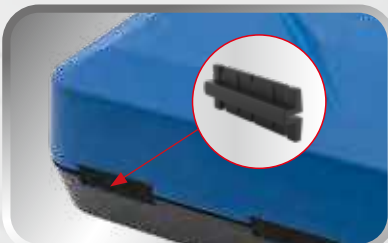

• Design de eixo de rotação integrado



- Chave padrão métrico 6PT: 5, 5.5, 6, 7, 8, 9, 10, 11, 12, 13, 14
- Bit (cabeça hexagonal): H2.5, H3, H4, H5, H6
- Bit (cabeça PHILLIPS): PH1, PH2, PH3
- Bit (cabeçote FECHADO): 4.0, 5.0, 6.0
- Bit (cabeça resistente TORX): T10H, T15H, T20H, T25H, T27H, T30H, T40H
- Bit (cabeça POZIDRIV): PZ1, PZ2, PZ3
- Bit (cabeça PHILLIPS): PH2
- Barra de extensão: 2", 4"
- Porta bits: 25 mm
- Cabo giratório: 150 mm
- Roquete à prova de poeira de 90 dentes: 150 mm
- Junta universal: 31 mm



23 PC. 3/4 DR Jogo de chaves de caixa

350.00€
6023MR



- 12PT Chave : 21, 22, 23, 24, 26, 27, 28, 29, 30, 32, 34, 35, 36, 38, 41, 46, 50
- Roquete 24 dentes : 500 mm
- Cabo em T : 500 mm
- Barra extensões : 4", 8", 16"
- Junta universal : 108 mm

350.00€
6323MR



- 6PT Chave : 21, 22, 23, 24, 26, 27, 28, 29, 30, 32, 34, 35, 36, 38, 41, 46, 50
- Roquete 24 dentes : 500 mm
- Cabo em T : 500 mm
- Barra extensões : 4", 8", 16"
- Junta universal : 108 mm

14 PC. 1"DR. Jogo de chaves de caixa 12PT

595.00€
8015MR



- Chave : 36, 41, 46, 50, 55, 60, 65, 70, 75, 80
- Roquete 24 dentes : 800 mm
- Barra extensão : 8" 16"
- Cabo em T : 630 mm



Please wear proper safety gear while working.

1/2" DR. Desandador de pancada

6 PC.

43.00€
4112FR



8 PC.

44.00€
4108FR



110 PC. 1/4" & 1/2"DR. Jogo de chaves de caixa

187.00€
SC7510MR

- 1/4"DR.
- 6PT Chave : 4, 4.5, 5, 5.5, 6, 7, 8, 9, 10, 11, 12, 13, 14 mm ; 6PT Chave Funda : 6, 7, 8, 9, 10, 11, 12, 13 mm ; Chave Estrela : E4, E5, E6, E7, E8 ; Chave Ponta : PH1, PH2 ; 4, 5.5, 6.5 ; T8, T10, T15, T20, T25, T27, T30 ; H3, H4, H5, H6 ; PZ1, PZ2 ; Junta Universal ; Barra extensão : 2", 4" ; Cabo em T : 115 mm ; Suporte Pontas Roquete ; Punho condutor : 6"
- 1/2"DR.
- 6PT Chave Funda : 14, 15, 17, 19, 22 mm ; 6PT Chaves : 10, 11, 12, 13, 14, 15, 16, 17, 18, 19, 20, 21, 22, 24, 27, 30, 32 mm ; Chaves Estrela : E10, E11, E12, E14, E16, E18, E20, E24 ; 6PT Chaves de velas : 16, 20.8 mm ; Junta universal : 77.5 mm ; Barra extensão : 10" ; Barra extensão : 5" ; Suporte pontas : 5/16"
- 5/16" Ponta
- PH3, PH4 ; 8 x 1.2, 10 x 1.6, 12 x 2.0 ; T40, T45, T50, T55 ; H8, H10, H12, H14 ; PZ3, PZ4
- 6 PT Chave Hexagonal : H1.5, H2, H2.5
- 8° de retoma
- 15° de retoma
- Triangular furo quadrado : 3/8"F*1/2"M
- Adaptador soquete : 25 mm



83 PC. 1/4"&1/2"DR. Jogo de Chaves de Caixa

173.00€
SC7583MR

- 1/4"DR.
- 6PT Chave : 4, 4.5, 5, 5.5, 6, 7, 8, 9, 10, 11, 12, 13, 14 mm ; Chave Ponta : PH1, PH2 ; 4, 5.5, 6.5 ; T8, T10, T15, T20, T25, T27, T30 ; H3, H4, H5, H6 ; PZ1, PZ2 ; Junta Universal ; Barra extensão : 2", 4" ; Punho condutor : 6" ; Barra extensão flexível : 150 mm ; Cabo em T : 115 mm
- 1/2"DR.
- 6PT Chave : 14, 15, 16, 17, 18, 19, 20, 22, 24, 27, 30, 32 mm ; 6PT Chaves de velas : 16, 20.8 mm ; Junta Universal : 77.5 mm ; Barra extensão : 10" ; Barra extensão : 125 mm ; Suporte Pontas : 5/16"
- 5/16" Ponta
- PH3, PH4 ; 8 x 1.2, 10 x 1.6, 12 x 2.0 ; T40, T45, T50, T55 ; H8, H10, H12, H14 ; PZ3, PZ4
- Chave Combinada : 8, 10, 11, 12, 13, 14, 17, 19
- Triangular furo quadrado : 3/8"F*1/2"M
- 8° de retoma
- 15° de retoma
- Lanterna 3W LED
- Adaptador soquete : 25 mm



143 PC. 1/4" & 1/2" DR. Jogo de chaves de caixa

445.00€
SC9543MR01

1/4" DR.

- 6PT Chave : 4, 4.5, 5, 5.5, 6, 7, 8, 9, 10 mm ; Chave Estrela : E4, E5, E6, E7, E8 ; Bit : PH0, PH1, PH2, PH3 : 4, 5.5, 7; T10, T15, T20, T25, T27, T30, T40 ; H2, H3, H4, H5, H6, H7, H8, H10 ; PZ0, PZ1, PZ2, PZ3 ; Barra extensão : 2", 4", 6" ; Barra extensão flexível : 6" ; Punho condutor : 6" ; Junta universal ; Suporte pontas : 25 mm

3/8" DR.

- 12PT Chave : 6, 7, 8, 9, 10, 11, 12, 13, 14, 15, 17, 18, 19, 21, 22 mm ; Barra extensão : 3", 6" ; Roquete reversível 32 dentes ; Junta universal : 50 mm ; Adaptador 3/8" F x 1/4" M

1/2" DR.

- 6PT Chave : 8, 10, 12, 13, 14, 15, 16, 17, 18, 19, 20, 21, 22, 23, 24, 25, 27, 30, 32 mm ; Chave Estrela : E10, E12, E14, E16, E20 ; Chaves de velas : 16, 20.8 mm ; Barra extensão : 3" ; Barra extensão : 10" ; Junta universal : 77.5 mm ; Cabo em L : 250 mm ; Punho flexível : 450 mm
- Chaves Combinadas : 6, 7, 8, 9, 10, 11, 12, 13, 14, 15, 16, 17, 18, 19, 21, 22, 24
- 6PT Chave Luneta Aberta : 8 x 10, 10 x 12, 11 x 13, 12 x 14, 17 x 19
- Chave Sextavada Padrão : H1.5, H2.0, H2.5, H3.0, H4.0, H5.0, H6.0, H8.0, H10
- Chave de Fenda PHILLIPS : PH2 x 38, PH1 x 80
- Chave de Fenda SLOTTED : 6.5 x 38, 5.5 x 75
- Chave de Fenda PHILLIPS : PH2 x 100
- Chave de Fenda SLOTTED : 6.5 x 150
- Triangular Furo Quadrado : 3/8" F * 1/2" M
- Desaperto rápido : 280 mm
- Alicates Combinados : 188 mm
- Fecho - Alicate de pressão : 225 mm
- Martelo : 300 mm
- 8° de retoma
- 15° de retoma
- Fita Métrica 3M
- Lanterna 3W LED



Jogo chaves caixa impacto 1/2"

- Ø Cx metálica (mm): : 270 x 73 x 46 (0.032 cuft)
- Chave de impacto padrão métrico 6PT: 10 , 12 , 13 , 14 , 17 , 19 , 21 , 24

38.00€

4408MP



8 PC.

- Ø Cx metálica (mm): : 270 x 100 x 49 (0.047 cuft)
- Chave de impacto padrão métrico 6PT: 10, 11, 12, 13, 14, 15, 16, 17, 18, 19, 21, 22, 24, 27

59.00€

4414MP



14 PC.

Jogo chaves caixa impacto 1/2" Longas

- Ø Cx metálica (mm): : 246 x 103 x 38 (0.034 cuft)
- 6PT Métrica impacto profundo Chave: 12 , 13 , 14 , 17 , 19 , 21 , 22 , 23

69.00€

4410MP



8 PC.

- Ø Cx metálica (mm): : 445 x 135 x 50 (0.021 cuft)
- 6PT Métrica impacto profundo Chave: 10 , 11 , 12 , 13 , 14 , 15 , 16 , 17 , 19 , 21 , 22 , 24 , 27 , 30 , 32

130.00€

4415MP03



15 PC.

Jogo chaves caixa 1/2" perfil sextavado interior

- Para parafuso de cabeça hexagonal
- 60mmL
- Ø Cx metálica (mm): : 198 x 105 x 32 (0.023 cuft)
- Chave de bit de impacto: H4, H5, H6, H8, H10, H12, H14

94.00€

4407MP



7 PC.

Jogo chaves caixa 1/2" perfil Torx

- Para parafuso interno torx
- 60mmL
- Ø Cx metálica (mm): : 198 x 105 x 32 (0.023 pés)
- chave de bits de impacto: T25 , T30 , T40 , T45 , T50 , T55 , T60

80.00€

4417PP



7 PC.

Chave para rodas Mercedes com proteção nylon

- Manga externa durável protege as rodas polidas e a porca
- Adequado para parafusos de roda híbridos em, por exemplo, MERCEDES-BENZ Classe C tipo 204, 204X Classe E tipo 211, 212, 207 SLK tipo 172 Classe M tipo 164, 166 Classe S tipo 221, 222 CL-Class tipo 216

10.00€

9BW4501



Chave para rodas Hyundai / Kia com proteção nylon

- A manga externa durável protege as rodas polidas e a porca
- Adequado para porcas de roda com perfil especial 21 mm em HYUNDAI i30, Tucson e KIA

10.00€

9BW4502



Jogo chaves caixa 1/2" perfil Torx

- Ø Estojo (mm): 149 x 132 x 45 (0.031 cuft)
- Chave de impacto de parede fina com luva de plástico
- A manga externa durável protege as rodas polidas e as porcas
- Chave de impacto de parede fina com luva de plástico: 17, 19, 21 mm

27.00€
44905MP

3 PC.



Jogo 3 chaves rodas longas

- 6PT Métrica impacto profundo Chave: 17, 19, 21 mm

21.00€
P4405MP1

3 PC.



Jogo 3 chaves rodas + 3 barras de torção

- Ø Cx metálica (mm): 296 x 130 x 41 (0.056 cuft)
- Chave de Impacto p/ porca da roda
- Barra de extensão de torque
- Chave de impacto de parede fina com luva de plástico: 17, 19, 21 mm
- Barra de extensão de torque: 90, 110, 200 N-m

94.00€
44906MP

6 PC.



Jogo chaves caixa 1/2" para extrair porcas danificadas

- Chave removedora de porcas danificadas: 21, 22, 23, 27
- Calha & Clip: 170 mm

76.00€
9TD034MR

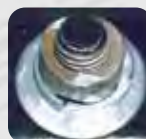
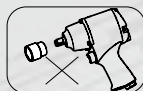

- Para remover porcas de roda danificadas e porcas de bloqueio. Especialmente útil em porcas de roda de assentamento profundo em ligas modernas
- Chave de design de torção para facilmente remover a porca Comprimento: 146mm

- Ø Estojo (mm): 187 x 140 x 50
- Chave de torção longa: 17, 19, 21 mm
- Vara de percussão: Ø12 x 160 mmL

84.00€
9TD164MR

4 PC.



- Ø Estojo (mm): 187 x 140 x 50
- Chave de torção longa: 17, 19, 21, 22 mm
- Vara de percussão: Ø12 x 160 mmL

111.00€
9TD165MR

5 PC.



Ferramentas Pneumáticas

1/4"DR. Aparafusadora pneumática

87.00€

33121



- Entrada ar : 1/4" BSPT
- Torque max. : 102 Nm / 75 ft.lb
- Tamanho : 1/4"
- Comprimento : 191 mm
- Peso : 0.82 kgs

Chave de impacto pneumática



171.00€

33431-050

- 1/2"DR. Chave de Impacto super leve
- Design Compacto; Comprimento total 109mm com 1,45kg
- Quadrado de níquel cromado molibdênio
- Martelo do mecanismo-jumbo
- Compt.Total : 4,3" poleg. (109mm)
- Pressão da mangueira : 3/8" ID
- Pressão de ar : 90 PSI (6,2 bar)
- Torque max : 678 Nm / 500ft.lb

1/2"DR. Std.Chave de impacto 650FT.Lbs(881NM)

201.00€

33431-065



- Entrada ar : 1/4" BSPT
- Torque máx.: 650 Nm / 8000ft.lb
- Comprimento : 175 mm
- Peso : 2.58 kgs

1/2"DR. Std. Chave de impacto pneumática



295.00€

33481-095

- Entrada ar : 1/4"
- Torque máx.: 1288 Nm / 950 ft.lb
- Comprimento : 197 mm
- Peso : 2.25 kgs

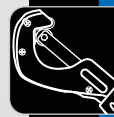

Chave de impacto pneumática compacta



228.00€
33491-030

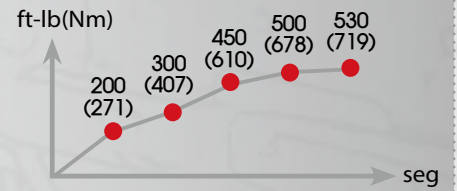

• 3-Velocidades

3 2 1

• Velocidade total no sentido Contrário

3

- Entrada ar : 1/4" BSPT
- Torque máx.: 407 Nm / 300 ft.lb
- Comprimento : 248 mm
- Peso : 1.40 kgs

3/4"DR. Std. Chave de impacto pneumática



318.00€
33681-100

- Entrada ar : 1/4"
- Torque máx.: 1491 Nm / 1100 ft.lb
- Comprimento : 211 mm
- Peso : 2.35 kgs

1/4"DR. Retificadora pneumática



37.00€
33A12-100

- Entrada ar : 1/4" BSPT
- Tamanho : 6 mm
- Comprimento : 168 mm
- Peso : 0.55 kgs

1"DR. Ext. Chave de impacto pneumática

-35% peso

780.00€
33862-200

Torção máxima 2000ft.lb !



- Entrada ar : 1/2" BSPT / NPT
- Torque max. : 2712 Nm / 2000 ft.lb
- Comprimento : 487 mm
- Peso : 8.10 kgs



Lixadora orbital

155.00€
33D13-010

124.00€
33D34-010

166.00€
33D23-010

136.00€
33D35-010

- Caixa composta com baixa vibração
- Conforto com formato de palma ergonômico
- 33D13-010 Aspiração Central
- 33D23-010 Vácuo auto-gerado
- 33D34-010 Sem vácuo
- 33D35-010 Sem vácuo



33D13-010



33D23-010



33D34-010 / 33D35-010

Rebitador pneumático

104.00€
33J11-100

259.00€
33J12-100

- Entrada ar : 1/4" BSPT/NPT
- Potência de Tração: 2680 lb-f / 11922 N-f
- Capacidade : 4.8 mm
- Comprimento do curso: 14 mm
- Peso : 3.30 kgs

- Entrada ar : 1/4" BSPT/NPT
- Potência de Tração: 4166 lb-f / 18532 N-f
- Capacidade : 6.4 mm
- Comprimento do curso: 19 mm
- Peso : 4.30 kgs



Soprador

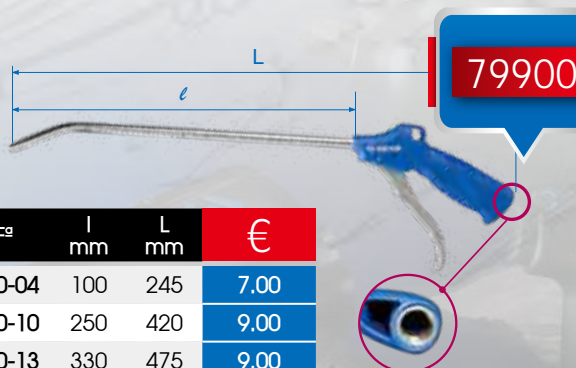

REF ^o	l mm	L mm	€
79900-04	100	245	7.00
79900-10	250	420	9.00
79900-13	330	475	9.00
79900-20	500	650	12.0

- Pressão : 5-8 bars
- Pressão max.: 13.8 bars

Enrolador de mangueira



242.00€
79912-15

- Comprimento mangueira : 15M
- Mangueira O.D. : 12 mm
- Mangueira I.D. : 8 mm
- Pressão trabalho : 20 bars

Mangueira de ar em espiral

32.00€
79962-10

41.00€
79962-15

49.00€
79962-20



Jogo máquina impacto pneumática 1/2"



402.00€
44801AMP

20
PC.

- Ø Estojo (mm): 422 x 275 x 85mm (0.35cuff)
- Chave de impacto padrão métrico 6PT: 10, 11, 12, 13, 14, 16, 17, 18, 19, 21, 22, 24
- Chave de impacto de parede fina com luva de plástico: 17, 19, 21 mm
- Chave de Impacto Super Duty Composite: 1/4" BSPT
- Barra de Extensão - Com Esfera: 75 mm
- Junta Universal - Com Esfera: 65 mm
- Acoplador rápido de ar (europeu): 1/4" BSPT
- Tanque de óleo

Jogo máquina impacto pneumática 3/4"



508.00€
64801AMP

18
PC.

- Ø Estojo (mm): 422 x 275 x 85mm(0.35 cuff)
- Chave de impacto padrão métrico 6PT: 19, 22, 24, 27, 30, 32, 36, 38
- Chave de Impacto Super Duty Composite: 1/4" BSPT
- Barra de Extensão - Com Esfera: 175 mm
- Junta Universal - Com Esfera: 114 mm
- Acoplador rápido de ar (europeu): 1/4" BSPT
- Tanque de óleo

264.00€
44802AMP

16
PC.



- Ø Estojo (mm): 340 x 263 x 80mm (0.253 cuff)
- Chave de impacto padrão métrico 6PT: 10, 12, 13, 14, 16, 17, 18, 19, 21, 22, 24
- Chave de mini impacto: 1/4" BSPT
- Barra de Extensão - Com Bola: 125 mm
- Junta Universal - Com Esfera: 59 mm
- Acoplador rápido de ar (europeu): 1/4" BSPT
- Tanque de óleo

Pistola de encher pneus com manómetro 3 em 1 (BSPT)



185

98M2-02

(incluído apenas no 9BM2210A)

82.00€

9BM2210A

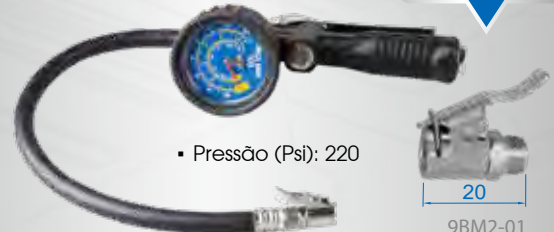

- Pressão (Psi): 220

20

9BM2-01

Pistola de lubrificar pneumática + Record flexível



70.00€

9BV1420T

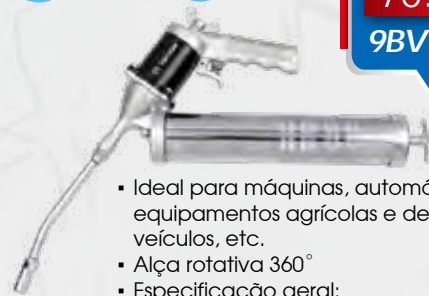

- Ideal para máquinas, automóveis, equipamentos agrícolas e de jardim, outros veículos, etc.
- Alça rotativa 360°
- Especificação geral:
- Pressão do ar de entrada: 90 psi (6,2 bar)
- Pressão de ar de saída: 3600 psi (250 bar)

Mini lubrificador para ferramentas pneumáticas

5.00€

33411-71

- 1/4" -19 BSPT



Torque Control & Multiplicadores

Chave dinamométrica C/roquete fixo 10"

Escala dupla

REF ^a	Encaixe	Alcance torque N·m	Alcance torque kgf·cm / kgf·m	€
34223-1A	1/4"	5~25 N·m	51~255 kgf·cm	44.00
34323-1A	3/8"	5~25 N·m	51~255 kgf·cm	46.00
34323-2A	3/8"	20~110 N·m	2.04~11.22 kgf·m	46.00
34423-1A	1/2"	42~210 N·m	4.3~21.4 kgf·m	46.00
34423-2A	1/2"	70~340 N·m	7.1~34.7 kgf·m	75.90

1/4" & 3/8"DR. Mini chave dinamométrica ajustável

DIN ISO 6789 & ASME B107.14M-2004
Tolerância de torque $\pm 3\%$ (CW)
CW/CCW

Escala simples - Newton (Nm)

REF ^a	Encaixe	Alcance torque N·m	€
3426C-1DF	1/4"	3~15 N·m	81.00
3426C-2DF	1/4"	5~25 N·m	85.00
3436C-1DF	3/8"	3~15 N·m	85.00
3436C-2DF	3/8"	5~25 N·m	88.00

Chave dinamométrica ajustável 72 dentes

Design para fácil ajuste de torque
DIN ISO 6789 & ASME B107.300-2010
Tolerância de torque $\pm 3\%$ (CW)
CW/CCW

Escala dupla

REF ^a	Encaixe	Alcance torque N·m	€
34862-2DG	1"	300~1500 N·m	800

Adaptador aumento 9x12 para 14x18

19.00€
34505102R



9 x 12

mm	mm	L1 mm	L mm	kg
9 x 12	14 x 18	20.5	45.5	82.2

Adaptador redução 14x18 para 9x12

23.00€
34505201R



14 x 18

mm	mm	L1 mm	L mm	kg
14 x 18	9 x 12	33.5	49.5	131.8



1/2"DR. CW/CCW Chave dinamométrica ajustável

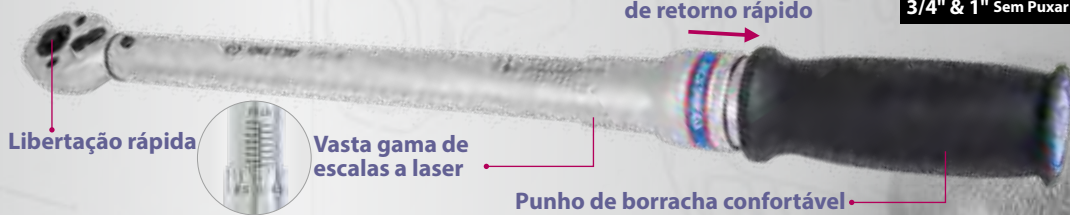

Escala dupla

REFª	Engr.	Quadra	Nível de torque N-m	Incr.	Comp.total mm	€
34262-1DG	24	1/4"	4~20 N-m	0.1 N-m	324	95
34262-2DG	24	1/4"	2~10 N-m	0.1 N-m	281	100
34362-1DG	24	3/8"	4~20 N-m	0.1 N-m	324	102
34362-2DG	32	3/8"	20~100 N-m	0.5 N-m	435	116
34362-3DG	32	3/8"	10~60 N-m	0.5 N-m	325	106
34462-1DG	32	1/2"	40~200 N-m	1 N-m	521	119
34462-2DG	32	1/2"	60~340 N-m	2 N-m	613	120
34662-1DG	24	3/4"	100~600 N-m	5 N-m	1048	389
34662-2DG	24	3/4"	150~800 N-m	5 N-m	1234	450
34662-3DG	24	3/4"	200~1000 N-m	5 N-m	1238	485
34862-1DG	24	1"	200~1000 N-m	5 N-m	1238	490

REFª	Encaixe	Alcance torque kgf-cm / kgf-m	Alcance torque N-m	€
34462-1GG	1/2"	400~2000 Kgf-cm	44.1~191.2 N-m	131
34462-2GG	1/2"	6~34 Kgf-m	68.6~323.6 N-m	132

Chave de medição angular

- Movimentação quadrada:
- 34440 (1/2" x 3/4")
- Escala de ângulo de 360° - claramente marcada em incrementos de 2° e em intervalos de 10° e 30°
- O indicador gravado na placa de plástico transparente protege a escala angular de lixto e graxa
- Braço ajustável mantém a escala angular estacionária
- O braço tem dois comprimentos para flexibilidade adicional na colocação dos componentes
- Mostrador resistente e com índice de rotação, permitindo ao operador restringir com precisão os padrões

22.00€
34440

28.00€
34440A

91.00€
34660

96.00€
34660A



Chave dinamométrica digital

264.00€
34367-2AG

238.00€
34467-1AG

Escala dupla

REFª	Encaixe	Alcance torque N-m	Alcance torque kgf-m
34367-2AG	3/8"	27-135 N-m	2.75~13.76 kgf-m
34467-1AG	1/2"	40-200 N-m	4.08~20.38 kgf-m

1/2"DR. Adaptador binário digital 40~200N·m

72.45€

34407-1A



• Indicações Importantes:

Precisão	± 2%
Memória	50
Resolução mostrador	0.1 N·m / ft·lb. , 0.01 kgf·m
Modo de operação	Peak/Trace
Seleção de unidades	kgf·m , ft·lb. , N·m
Bateria	AAA x 2 PC.
Duração bateria	110hrs (uso contínuo)
Temperaturas de operação	-10°C - 60°C (13.9°F - 139.9°F)
Temperaturas armazenamento	-20°C - 70°C (-4°F - 157.9°F)
Humidade de operação	15 to 90% sem condensação
Desliga automaticamente	70 segundos (se não usar)
Indicador LED	Verde. Amarelo. Vermelho



3/4"DR. Adaptador binário digital 200~1000N·m

140.00€

34607-1A



• Indicações Importantes:

Precisão	± 2%
Memória	50
Resolução mostrador	0.1 N·m / ft·lb. , 0.01 kgf·m
Modo de operação	Peak/Trace
Seleção de unidades	kgf·m , ft·lb. , N·m
Bateria	AA x 2 PC.
Duração bateria	110hrs (uso contínuo)
Temperaturas de operação	-10°C - 60°C (13.9°F - 139.9°F)
Temperaturas armazenamento	-20°C - 70°C (-4°F - 157.9°F)
Humidade de operação	15 to 90% sem condensação
Desliga automaticamente	80 segundos (se não usar)
Indicador LED	Verde. Amarelo. Vermelho
Alerta sobrecarga	1200 N·m (886 ft·lb.)

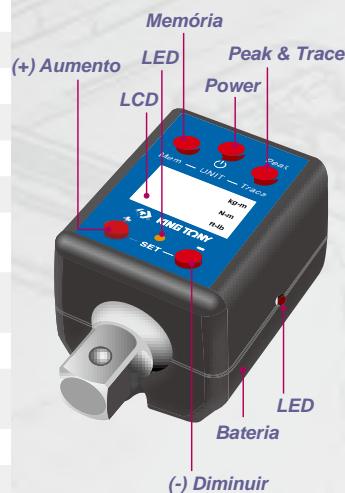

Jogo conversor de torque universal

128.00€

3488A03MP

Conteúdo	
	Dispositivo aprimorado de energia 1 PC.
	Poste prolongado 1 PC.
	Punho 1 PC.
8835M	32, 33

REF ²	Ratio	Entr. quad.	Saída quad.	Torque max. saída+ Nm / ft.lb	
3488A03MP	47 : 1	1"	1"	4700 / 3466	9.3





Chaves



Chave de boca luneta

10A0



REFª	Tam. mm	€	REFª	Tam. mm	€
10A0-24	24	18.00	10A0-75	75	122.00
10A0-27	27	18.00	10A0-80	80	165.00
10A0-30	30	20.00	10A0-85	85	174.00
10A0-32	32	20.00	10A0-90	90	217.00
10A0-36	36	25.00	10A0-95	95	225.00
10A0-41	41	33.00	10A0-A0	100	339.00
10A0-46	46	45.00	10A0-A5	105	303.00
10A0-50	50	53.00	10A0-B0	110	334.00
10A0-55	55	64.00	10A0-B5	115	388.00
10A0-60	60	76.00	10A0-C0	120	420.00
10A0-65	65	97.00	10A0-C5	125	453.00
10A0-70	70	114.00			

Chave de pancada luneta

10B0



REFª	Tam. mm	€	REFª	Tam. mm	€
10B0-24	24	13.00	10B0-70	70	97.00
10B0-27	27	15.00	10B0-75	75	103.00
10B0-30	30	18.50	10B0-80	80	113.00
10B0-32	32	21.00	10B0-85	85	133.00
10B0-36	36	25.80	10B0-90	90	158.00
10B0-41	41	34.20	10B0-95	95	172.00
10B0-46	46	42.00	10B0-A0	100	200.00
10B0-50	50	47.00	10B0-A5	105	225.00
10B0-55	55	58.00	10B0-B0	110	277.00
10B0-60	60	61.00	10B0-B5	115	294.00
10B0-65	65	78.00	10B0-C0	120	330.00

8 PC Jogo de chaves de bocas



36.00€
1108MR

- 6 x 7, 8 x 9, 10 x 11, 12 x 13, 14 x 15, 16 x 17, 18 x 19, 20 x 22

12 PC. Jogo de chaves bocas



76.00€
1112MR

- 6 x 7, 8 x 9, 10 x 11, 12 x 13, 14 x 15, 16 x 17, 18 x 19, 20 x 22, 21 x 23, 24 x 27, 25 x 28, 30 x 32

14 PC. Jogo de chaves mistas c/ roquete



190.00€
12114MRN

- 8, 9, 10, 11, 12, 13, 14, 15, 16, 17, 18, 19, 22, 24

26 PC. Jogo de chaves mistas



185.00€
1226MRN

- 6, 7, 8, 9, 10, 11, 12, 13, 14, 15, 16, 17, 18, 19, 20, 21, 22, 23, 24, 25, 26, 27, 28, 29, 30, 32

14 PC. Jogo de chaves mistas



95.00€
1214MR

- 10, 11, 12, 13, 14, 16, 17, 19, 21, 22, 24, 27, 30, 32

12 PC. Jogo de chaves mistas



54.00€
1212MR

- 8, 9, 10, 11, 12, 13, 14, 15, 16, 17, 19, 22



- Fácil de identificar
- Transportar com uma mão



- Estrutura elástica
- Armazenamento rápido



- Buraco de suspensão



9 PC. Jogo chaves boca/luneta em suporte

60.00€
12D09MRS01

- Chaves combinadas: 6, 8, 10, 11, 13, 14, 15, 17, 19

9 PC. Jogo chaves boca/luneta com roquete em suporte

170.00€
12209MRS01

- Chave de velocidade reversível: 8, 10, 11, 12, 13, 14, 15, 17, 19

8 PC. Jogo chaves boca/luneta com roquete em suporte (Polg.)

150.00€
12208SRS

- Chave de velocidade reversível: 5/16", 3/8", 7/16", 1/2", 9/16", 5/8", 11/16", 3/4"

1/2"DR. Chave para porcas de roda



25.00€
19911722

- Tamanho : 17, 19, 21, 22 mm

3/4"DR. Chave para porcas de roda



72.00€
19932427

- Tamanho : 24, 27, 32 mm

8 PC. Jogo de Chaves Luneta Plana



46.00€
1C08MR

- Tamanho : 6 x 7, 8 x 9, 10 x 11, 12 x 13, 14 x 15, 16 x 17, 18 x 19, 20 x 22

12 PC. Jogo de Chaves Luneta Plana



103.00€
1C12MR

- Tamanho : 6 x 7, 8 x 9, 10 x 11, 12 x 13, 14 x 15, 16 x 17, 18 x 19, 20 x 22, 21 x 23, 24 x 26, 25 x 28, 30 x 32

2 PC. Chave luneta com roquete 8 medidas métricas



- 4 Tamanhos numa chave, tamanhos comuns para aplicações gerais

51.00€
14902MR01

- 8 x 10 x 12 x 13, 14 x 17 x 18 x 19

Chave luneta com roquete 8 medidas polegadas

51.00€
14902SR

- 5/16 x 3/8 x 7/16 x 1/2, 9/16 x 5/8 x 11/16 x 3/4



Chave de gancho articulada

- A junta é equipada com uma arruela de pressão para garantir uma operação suave e confiável
- Aço de liga de cromo vanádio

3641

REFª	mm	L mm	€
3641-35	13-35	174	16.00
3641-50	35-50	212	21.00
3641-80	50-80	285	28.00
3641-C0	80-120	348	45.00
3641-I0	120-180	480	61.00

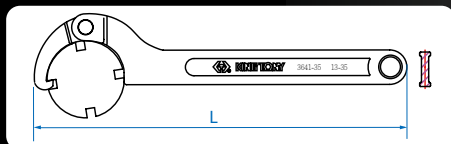

Chave ajustável multifunções

34.00€

3616-10

- Capacidade(mm):8~17, 14~32



• Spline 12 pontos



• Torx



• Quadrado



• Hexagonal



• 70% Redondo

Chave ajustável

3611



3611R

REFª	mm	L mm	€
3611-06R	20	150	10.70
3611-08R	25	200	12.50
3611-10R	30	250	17.70
3611-12R	35	300	21.00

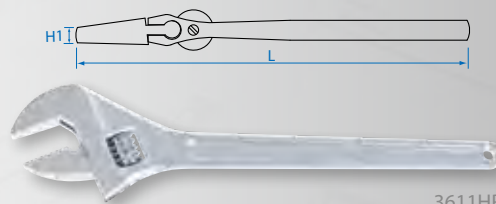

3611HR

REFª	mm	L mm	€
3611-15HR	43	375	44.00
3611-18HR	52	450	77.00
3611-24HR	62	600	144.00

Chave ajustável 10"

35.00€

3631-10R

REFª	mm	Comprimento mm
3631-10R	32	250



Alicates



4 PC. Jogo alicates

60.00€
42104GP01



- Alicates Combinados : 163 mm
- Alicate de Corte Digonal : 163 mm
- Alicate de Pontas : 200 mm
- Alicate Junta Ajustável Tipo Alemão : 253 mm

4 PC. Jogo alicates

62.00€
42114GP



- Alicate Angulado Circlip : 170 mm Para anéis de retenção internos
- Alicate Direito Circlip : 180 mm Para anéis de retenção internos
- Alicate Angulado Circlip : 170 mm Para anéis de retenção internos
- Alicate Direito Circlip : 180 mm Para anéis de retenção internos

Alicate de pressão

18.00€
6011-10R



- Comprimento : 225 mm
- Capacidade garra : 48 mm

Alicate de bloqueio com garra reta 7"

18.00€
6031-10R

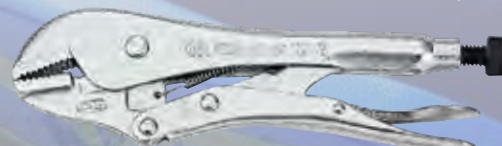

- Comprimento : 254 mm
- Capacidade garra : 45 mm

Alicate universal



6111

REF ^o	L mm	€
6111-06	163	13.00
6111-08	213	18.00

Alicate ajustável fecho rápido



6131

REF ^o	L mm	€
6131-12	300	25.50
6131-14	350	30.00
6131-18	450	40.00
6131-24	600	50.00
6131-30	750	72.00
6131-36	900	90.00
6131-42	1050	135.00



Corta-cavilhas compacto 8"

- Tipo de serviço pesado
- DIN ISO 574
- corte central



45.00€

6133-08

- Comprimento : 212 mm

Alicate de corte diagonal



14.00€

6231-07

- Comprimento : 188 mm

Alicate pontas extra longo



13.00€

6311-06

- Comprimento : 164 mm

Alicate de pontas



16.50€

6311-08

- Comprimento : 200 mm

Alicate de corte diagonal



13.00€

6211-06

- Comprimento : 163 mm

Alicate de pontas articulado 13"



28.00€

6329-13C

- Comprimento : 340 mm
- Capacidade da mandíbula : 50 mm

Alicate ajustável para canalizador

47.00€
6518-10C



- Aumente o alcance útil de porcas Tam.s
- As mandíbulas são perfeitamente lisas
- Ergonomicamente projetado fácil de útil



- 17 posições de ajuste rápido e fácil de botão
- 42 mm máx. abertura



- Ação de catraca



Polg.	L mm	A mm	B mm	mm
10	266	45	35.5	57



Alicate ajustável

6511



REF ^o	mm	L mm	€
6511-10C	50	253	21.00
6511-13C	65	325	24.00
6511-17C	100	425	40.00

Alicate junta ajustável fecho rápido

6517



REF ^o	mm	L mm	€
6517-08C	40	200	28.00
6517-10C	60	250	31.00
6517-12C	70	310	32.00

Alicate junta ajustável

17.00€
6516-10C



- Comprimento : 253 mm
- 36 mm



Alicate curvo p/anéis



20.50€
68HB-07L

- Comprimento : 180 mm
- Capacidade Ø mm : 19~60mm

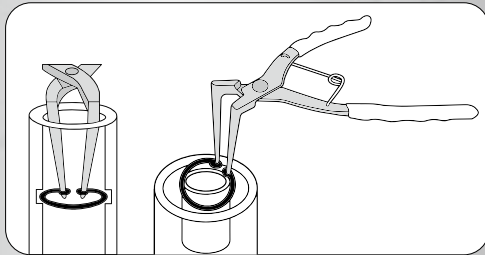

Alicate furador 2 a 4,5 mm

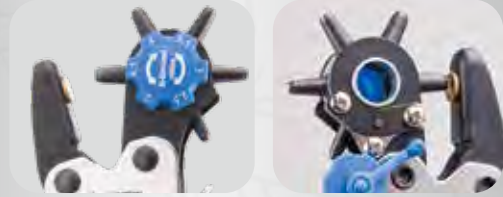

26.00€
74A00



- Para perfurar couro, tecidos e materiais macios
- A cabeça giratória de aço possui uma instalação exclusiva de recolha de resíduos
- Tam. Ø mm: 2, 2,5, 3, 3,5, 4, 4,5

Alicate freios interiores

13.00€
68HS-07

14.50€
68HB-07



68HS

68HB

- Para anéis de retenção internos
- Padrão reto e angular
- DIN 5254, DIN 5256



Tipo interno

Tipo europeu

- Comprimento : 7"-180 mm, 6-3/4"-170 mm
- Capacidade Ø mm : 19~60mm

Alicate freios exteriores

13.00€
68SS-07

14.50€
68SB-07



68SS

68SB

- Para anéis de retenção externos
- Padrão reto e angular
- DIN 5254, DIN 5256



Tipo externo

Tipo europeu

- Comprimento : 7"-180 mm, 6-3/4"-170 mm
- Capacidade Ø mm : 19~60mm

Alicate freios retos

14.00€
65SS-07



65SS

- Projeto de mola oculta
- DIN 5254 & DIN 5256



Tipo externo

- Comprimento : 7"-188 mm
- Capacidade Ø mm : 19~60mm

2.4~4.8 mm Rebitador

- L : 260 mm
- \varnothing : 2.4, 3.2, 4.0, 4.8

23.00€
21-20-101



2.4~4.8 mm 2 Rebitador profissional

- L : 278 mm
- \varnothing : 2.4, 3.2, 4.0, 4.8

31.00€
21-20-102





85 PC. Jogo de rebitador de porcas cegas

67.00€
21-30-09MR



Conteúdo:

	
M4 x 0.7 x 20 PC.	M4 x 0.7
M5 x 0.8 x 20 PC.	M5 x 0.8
M6 x 1.0 x 20 PC.	M6 x 1.0
M8x 1.25 x 20 PC.	M8x 1.25

Rebitador

- L : 460 mm
- \varnothing : 3.2, 4.0, 4.8, 6.4

50.00€
79711

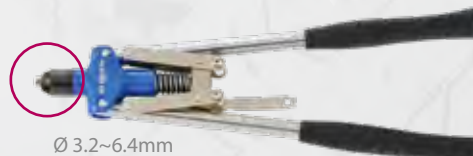

Rebitado de porcas em aço inox

73.00€
79731



Alicates para tubos de combustíveis

28.00€
9AB11



- Adequado para VW-Audi, Fiat, GM, Opel/Vauxhall, Mercedes-Benz
- Comprimento : 228 mm

19.00€
9AB12

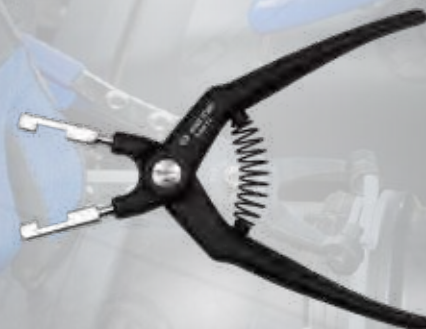

- Utilizar em VW, PSA , Fiat, Opel
- Comprimento : 150 mm





Alicate p/ abraçadeiras

18.00€
9AA16



• Ø : 60 mm

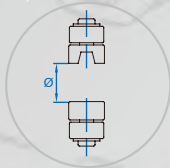

Alicate de grampo curvo flexível

60.00€
9AA31



• L1 : 630 mm
• Ø : 53 mm

Alicate para tubo de combustível

19.00€
9AA17



• Adequado a VW,
Audi, SEAT, Skoda
• Ø : 27 mm

Alicate para substituição do cabo do travão de mão

23.00€
9BC11



Alicate curvo para abraçadeira

15.00€
9AA21



• Ø : 53 mm

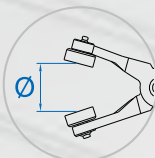

Alicate para remover apoio de borracha do escape

20.00€
9BP11



Alicate 360° para abraçadeiras

31.00€
9AA25



• Adequado a VW, Audi, Opel, Citroen,
Peugeot, Fiat, Renault, Mercedes-Benz
• Ø : 32 mm

Alicate para retirar cabos e cachimbos das velas

13.00€
9DB201



Ferramentas p/Tubos



Chave de tubos "S"

6521

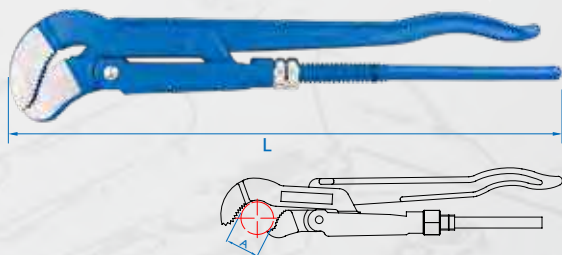

REFª	A mm	Tam. pol	Comprimento pol	Comprimento mm	€
6521-09	13	1/2	9-1/4	235	22.00
6521-13	25	1	13	330	28.00
6521-16	38	1-1/2	16-1/2	420	36.00
6521-21	51	2	21	535	58.00
6521-26	76	3	25-5/8	652	108.00

Chave de tubos em alumínio

6533



REFª	L mm	€
6533-10L	254	23.00
6533-12L	300	27.00
6533-14L	356	30.00
6533-18L	455	50.00
6533-24L	600	70.00
6533-36L	910	140.00
6533-48L	1200	260.00

Chave de tubos

6532

REFª	L mm	€
6532-08	180	9.00
6532-10	245	11.00
6532-12	275	14.00
6532-14	315	18.00
6532-18	400	26.00
6532-24	525	37.00
6532-36	720	69.00
6532-48	1025	110.00



Corta tubos com toque 6-42mm



15.00€

7913-42



Corta tubos



- Comprimento : 140 mm
- \odot : 3~35 mm
- \odot max. : 1.2 mm

21.00€

7914A-35



56.00€

7914C-70

- Comprimento : 222 mm
- \odot : 6~70 mm
- \odot max. : 1.2 mm



12.00€

7915-30

- Comprimento : 140 mm
- \odot : 3~30 mm
- \odot max. : 1.2 mm

Mini corta-tubos cobre



9.00€

7915A-19

- Comprimento : 62 mm
- \odot : 3~19 mm
- \odot max. : 1.2 mm



13.00€

7915A-28

- Comprimento : 70 mm
- \odot : 3~28 mm
- \odot max. : 1.2 mm

Tesoura corta-tubos PVC com roquete 6 a 63 mm

- Comprimento : 293 mm
- \odot : 6~63 mm

71.00€

7913A-63



Corta-tubos aço 43 a 114 mm

- Comprimento : 900 mm
- \odot : 43~114 mm
- \odot max. : 3 mm

137.00€

7918-A0



7 PC. Jogo de roscagem (BSPT)



518.00€

7CA0606S

- Use para rosca o tubo
- Tamanhos: 4 pcs 1/2", 3/4", 1" e 1-1/4"
- Conjunto de rosca catraca com punho extensível



Curvador de tubos cobre



180°

45°



7CA11

REF ²	Polg.	max. (Polg.)	R(radius) Polg.	Medidas mm	length mm	€
7CA11-12S	3/8	0.035	15/16	24	13 334	40.00
7CA11-16S	1/2	0.049	1-1/2	38	20 493	49.00

Chave com roquete para radiadores

40.00€

7HA03



4724DK



Hexagon A/F



Chave tubos ajuste rápido

3616S

- Capacidade Ø:
12~28mm, 20~48mm

KT NO.	Capacity mm	g	€
3616S-08P	12-28	345	51.00
3616S-14P	20-48	883	73.00



- Fácil e rápido de operar com uma mão

- Ação de catraca rápida

- O design especial da mandíbula fornece aderência extra forte

10 PC. Kit aborcadador

66.00€

7CA0110S



Conteúdo

1.68 1 / 12

7915-30



3-30 mm
1/8~1-1/8"

7CA22P20S



3/16", 1/4", 5/16", 3/8",
7/16", 1/2", 5/8"

7CA22P01



Adaptador para expansor



3/16", 1/4", 5/16", 3/8",
7/16", 1/2", 5/8"

Chave cinta de borracha para tubos

- Capacidade Ø:
20~100mm (L: 150 mm)
20~150 mm (L: 185 mm)

14.00€

320804



KT NO.

Overall length
inch mm

Capacity
mm



€

320804

6

150

Ø 20~100

133

14.00

320806

7-1/4

185

Ø 20~150

350

21.00



- Mecanismo de bloqueio rápido

- Alça ergonômica de conforto



Chave de Fenda & Chaves-L & Bits

33 PC. 10mm Jogo de pontas



28.00€
1032CO01

- 1/4" Ponta : 3.0, 4.0, 5.0, 6.0 ; PH1, PH2 x 2, PH3 ; PZ1, PZ2 x 2, PZ3 ; T10, T15, T20, T25, T27, T30, T40 ; H3, H4, H5, H6 ; T10H, T15H, T20H, T25H, T27H, T30H, T40H; RB2
- Suporte pontas magnético com encaixe Q.R. : 63 mm
- Adaptador chave : 25 mm

44 PC. 10mm Jogo de pontas



79.00€
1044CO

- H4, H5, H6, H7, H8, H10, H12 ; M5, M6, M8, M10, M12 ; T20, T25, T27, T30, T40, T45, T50, T55, T60 ; H4, H5, H6, H7, H8, H10, H12 ; M5, M6, M8, M10, M12
- Ponta (cabeça TORX) 80mmL : T20, T25, T27, T30, T40, T45, T50, T55, T60
- 3/8"DR. Suporte pontas : 10 mm
- 1/2"DR. Suporte pontas : 10 mm

Roquete de quadra 1/4"



2747

- A estrutura especial semelhante a um giroscópio permite soltar ou travar objetos com vários ângulos

REF ^o	Ø (mm)	H (mm)	Dentes	€
○2747	50	25	72	26.00
■2747DR	50	25	72	25.00



2747DR

2747

Roquete para bits 1/4"

20.00€

2746



49 PC. Jogo de bits + Porta bits 2746



50.00€
1048MR



Tam.cx plástico (mm):
150 x 102 x 46 (0.025 cuft)



1/4" Bit

- Cabeça hexagonal: H3, H4, H5, H6
- Cabeça PHILLIPS: PH1 x 2, PH2 x 2 (ø6mm), PH3, PH2 (ø4,7mm)
- Cabeça FECHADA: 3,0 x 0,5, 4,0 x 0,5, 5,0 x 0,8, 6,0 x 1,0
- Cabeça TORX: T10, T15, T20 x 2, T25, T27, T30, T40
- Cabeça resistente a adulteração TORX: T10H, T15H, T20H x 2, T25H, T27H, T30H, T40H
- Cabeça POZIDRIV: PZ2 x 2

1/4" Power Bit

- Cabeça hexagonal: H3, H4, H5, H6, H7, H8
- Cabeça PHILLIPS: PH2 x 2
- Cabeça FECHADA: 4,0 x 0,8, 6,0 x 1,0
- Cabeça TORX: T15, T20, T25
- Cabeça POZIDRIV: PZ2

- Chave de fenda 1/4": 72 mm
- Suporte magnético para bits: 75 mm
- Porta Bits Magnético Com Q.R. Manga: 63 mm

45 PC. Jogo de bits + Adaptador angular 759-140



84.00€
1045MR01-EB



40.00€
759-140



KT NO.	inch	Overall length (mm)	
759-140	1/4	140	305

1/4" Bit

- Cabeça hexagonal: H2, H3, H4, H5, H6
- Cabeça PHILLIPS: PH2 x 2 ø4,7mm
- Cabeça FECHADA: 4,0 x 0,5, 5,5 x 0,8, 6,5 x 1,2
- Cabeça TORX: T10, T15, T20, T25, T27, T30, T35, T40
- Cabeça resistente a adulteração TORX: T10H, T15H, T20H x 2, T25H, T27H, T30H, T40H
- Cabeça POZIDRIV: PZ1, PZ2, PZ3
- Cabeça QUADRADA: RB1, RB2, RB3

1/4" Power Bit

- Cabeça DUPLO PHILLIPS: PH1, PH2 x 2, PH3
- Cabeça PHILLIPS: PH2
- Brocas HSS revestidas de titânio: 3, 4, 5

- Ajustador de porcas: x 65L 8, 10, 13
- Suporte magnético para bits: 50 mm
- Adaptador de soquete: 50 mm
- Suporte de broca de ângulo reto para serviço pesado: 140 mm



47 PC. Jogo de bits + Chaves caixa



82.00€

2547MR-EB



1/4" DR.

- Encaixe padrão métrica PT: 4, 4,5, 5, 5,5, 6, 7, 8, 9, 10, 11, 12, 13, 14
- Encaixe Estrela: E4, E5, E6, E7, E8, E10
- Encaixe de bits PHILLIPS: PH1, PH2, PH3
- Encaixe de bit com fenda: 3,5, 4, 5,5, 6,5, 8
- Encaixe de bits TORX: T8, T9, T10, T15, T20, T25, T27, T30, T40
- HEXAGON Bit Soquete: H3, H4, H5, H6, H8
- Encaixe de bits POZIDRIV: PZ1, PZ2
- Adaptador 1/4" F x 3/8" M
- Adaptador de encaixe de 50 mm:
- 1/4" DR., 3/8" DR., 1/2" DR.

26 PC. Jogo de bits + Mini-roquete porta-bites 1/4"



- Fácil de manusear

42.00€

1026CQ-AM



- Rack de bits de elevação automática

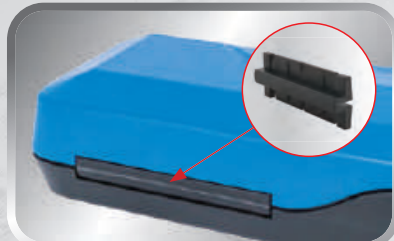

- Design de eixo de rotação integrado



- Adequado para bolso



1/4" DR.

- Cabeça hexagonal: H3, H4, H5, H6, H8
- Cabeça PHILLIPS: PH1, PH2, PH3
- Cabeça TORX: T10, T15, T20, T25, T27, T30, T40
- Cabeça resistente a adulterações TORX: T10H, T15H, T20H, T25H, T30H
- Cabeça POZIDRIV: PZ1, PZ2, PZ3
- Adaptador de soquete: 25 mm
- Porta Bits Magnético Com Q.R. Manga: 63 mm
- Mini catraca

10 PC. Jogo brocas HSS encabadouro 1/4"

Ø mm	Compr. total:mm
1.5	62
2	69
2.5	77
3	82
3.2	85
3.5	90
4	95
4.5	100
4.8	105
5	106

15.00€

11101SQ



6 PC. Jogo extratores 1/4" parafusos cabeças danificadas

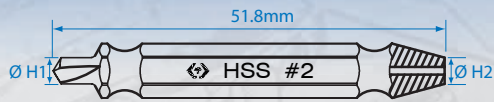

17.00€

11406SQ



Especificações	Broca Tam. Ø H1	Capacid.Parafuso Ø H2
HSS #0	2.5	2-3mm
HSS #1	3.0	3-5mm
HSS #2	3.5	4-8mm
HSS #2	3.5	4-8mm
HSS #3	4.0	5-10mm
HSS #4	6.0	6-12mm



3 Passos:

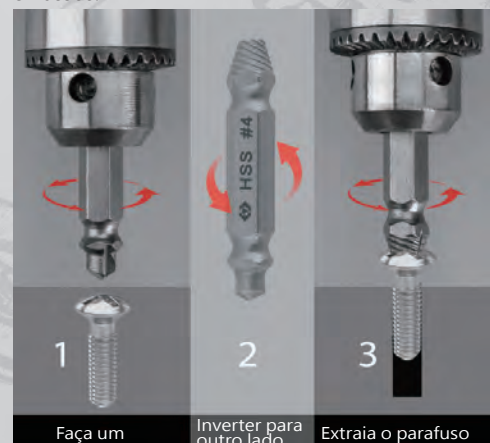

Punho porta-bits extensível com roquete 1/4"

- Conjunto de chave de fenda catraca 8 em 1
- Chave de fenda reversível com torque máximo de 45 Nm
- 45 dentes
- Fixador de porcas magnético 1/4" e porta-bits
- Lâminas estendidas máx. 135mmL
- Unidade estendida para espaços de difícil alcance

20.00€

32808MR

- Punho ergonômico



- Chave de fenda catraca telescópica

- Chave de fenda telescópica 45T
- Cabeça PHILLIPS: PH1, PH2
- Cabeça POZIDRIV: PZ2
- Cabeça FECHADA: 4,0 x 0,5, 5,5 x 0,8, 6,5 x 1,2

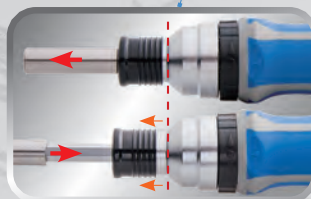

- Porta-bits magnético estendido



- Frente, reverso e neutro



- tampa do compartimento de armazenamento de 6 bits

Aparafusadora elétrica 1/4"

- Operação eficiente, 4 vezes mais rápida que a chave de fenda manual
- Adequado para qualquer tipo de reparação doméstica
- Torque: 1Nm (elétrico), 15Nm (manual).
- Velocidade de rotação: 280rpm.
- Bateria recarregável USB Li-ion 3.6V 18650 20000mah
- 3 LED luz acende automaticamente quando em uso
- Tamanho compacto, peso leve, fácil de usar
- Punho ergonômico de conforto
- Tempo de carregamento: 60 minutos
- Tempo de operação: 240 minutos
- Especificação: haste de broca de 1/4" 6,35 mm
- Conteúdo: Cabo Micro USB, PH2 bits x 110mm

66.00€

24102MP

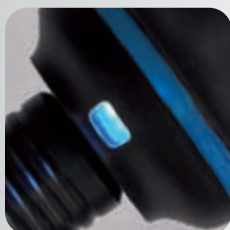

- luz de trabalho LED



- Porta micro USB e indicador de carregamento

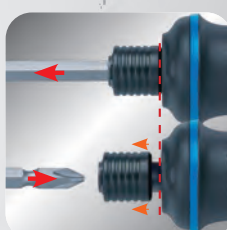

- Liberação rápida



- Botão Avançar/ Retroceder

8 PC. Jogo de chaves de fenda



34.00€
30118MR

- 3 x 75, 5 x 75, 5 x 100, 8 x 150, 8 x 200, 6,5 x 100, 6,5 x 150, 6,5 x 38

8 PC. Jogo de chaves de fenda em caixa de metal



41.00€
33108MR

- PH0 x 60, PH1 x 100, PH2 x 100, PH2 x 38, 3 x 75, 5,5 x 100, 6,5 x 38, 6,5 x 100

7 PC. Jogo de chaves de fenda pozidrive



33.00€
30127MR

- PZ1 x 80, PZ2 x 100, PZ3 x 150, 4 x 100, 5,5 x 125, 6,5 x 150, 8 x 175

7 PC. Jogo chaves philips



29.00€
31107MR

- PH0 x 60, PH1 x 80, PH1 x 100, PH2 x 38, PH2 x 100, PH2 x 150, PH3 x 150

Chave em T com ponta hexagonal

1195



7 PC. Jogo de chaves torx



30.00€
30317PR

- T10 x 75, T15 x 75, T20 x 100, T25 x 100, T27 x 100, T30 x 125, T40 x 150

REF ^o	mm	mm	mm	€
119502M	H2	64	126.5	9.00
119525M	H2.5	64	126.5	9.00
119503M	H3	64	126.5	9.00
119504M	H4	89.5	181	10.00
119505M	H5	89.5	182	10.00
119506M	H6	105	210	13.00
119508M	H8	124	250	15.00
119510M	H10	145	300	18.00

6 PC. Jogo de chaves de fenda/philips



24.00€
31116MR

- PH0 x 60, PH1 x 80, PH2 x 100; 3 x 75, 5,5 x 100, 6,5 x 150

Chave de porcas flexível

1453



REF ^o	mm	mm	mm	mm	mm	€
1453-05	5	14.3	190	300	136	7.00
1453-06	6	14.1	190	300	135	7.00
1453-07	7	14.5	190	300	134	7.00
1453-08	8	13.2	190	300	133	7.00
1453-10	10	12.7	190	300	132	8.00

9 PC. Jogo chaves "L" sextavado interior coloridas cabeça boleada

- O código de cores de acordo com o tamanho facilita a distinção e permite um trabalho mais rápido
- Esta chave hexagonal profissional é feita de material S2
- O design exclusivo na parte inferior da cabeça esférica possui um ângulo de inclinação de 25 graus que permite fácil operação em espaços estreitos
- O rack pode ser aberto e as chaves são fáceis de retirar
- Fácil de identificar com as gravações internas



cor	mm	L mm
rosa	H1.5	92
roxo	H2	102
azul claro	H2.5	115
verde	H3	129
amarelo	H4	144
laranja	H5	165
vermelho	H6	186
marrom	H8	208
azul escuro	H10	234



25.00€
20109MW

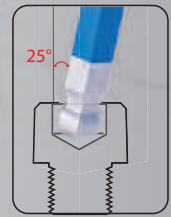

Magnetizador / Desmagnetizador



- Magnetizador



- Desmagnetizador



5.00€
79B1-01

Pesca-peças fléxivel magnético



2121

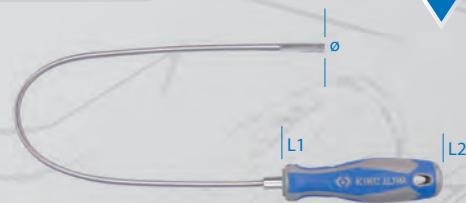

REFª	Tam.	Ø x compr. (mm)	Magnético	€	
		L1 L2	pot. (kg)		
2121-12	12"	Ø 7 x 305	415	0.5	7.70
2121-18	18"	Ø 7 x 457	567	0.5	8.25

8 PC. Jogo chaves "T" sextavado interior punho rotativo



- Velocidade e Eficiência



- Bujão de Bloqueio



- Extensão

- Chave de punho em T: H2, H2.5, H3, H4, H5, H6, H8, H10



89.00€
23208MR



FERRAMENTAS ISOLADAS VDE

18 PC. 1/4" DR. Jogo de chaves mistas VDE

- IEC 60900:2012
- Tam.caixa (mm): 294 x 231 x 66 (1.835cuft)

205.00€
25VE01MRV



- Chaves: 5, 6, 7, 8, 9, 10, 11, 12, 13, 14
- Chave Hex.: H3, H4, H5, H6
- Extensão 100mm, 150mm
- Chave T 150mm
- Roquete 125mm

7 PC. Jogo de chaves de fenda VDE

39.00€
30607MR



- 4 x 100, 5,5 x 125, 6,5 x 150, 8,0 x 175 ; PZ1 x 100, PZ2 x 100, PZ3 x 150

37.00€
30617MR



- PH1 x 100, PH2 x 100, PH3 x 150 ; 4 x 100, 5,5 x 125, 6,5 x 150, 8,0 x 175

3 PC. Jogo combinado de alicates VDE

68.00€
40603GP



- Combinação : 185 mm
- Alicata de Corte Diagonal : 167 mm
- Alicata de Pontas : 210

14 PC. 3/8"DR. Jogo de chaves mistas VDE

- IEC 60900:2012
- Tam. Caixa(mm): 389 x 229 x 66 (1.49cuft)

235.00€
35VE01MRV

- Chaves: 10, 11, 13, 14, 17, 19
- Chaves Hex.: H5, H6, H8
- Extensão 150mm, 200mm
- Chave T 200mm
- Roquete 200mm



Chave ajustável VDE

3611VE



KT NO.	mm	L mm		€
3611VE-06	24	164	167	36.00
3611VE-08	28	212	273	46.00
3611VE-10	32	260	497	58.00
3611VE-12	38	310	679	76.00

16PC. 1/2"DR. Jogo chaves de caixa misto VDE

- IEC 60900:2012
- Tam. Caixa(mm): 389 x 229 x 66 (1.49cuft)

310.00€
45VE01MRV

- Chave: 8, 10, 12, 13, 14, 17, 19, 21, 22, 24
- Chave Hex.: H8, H10
- Extensão 125mm, 250mm
- Chave T 200mm
- Roquete 250mm



Eletrônica & Elétrica



8 PC. Jogo chaves precisão fenda / philips



29.00€
32118MR

- PH000 x 75, PH00 x 75, PH0 x 75, PH1 x 75
- 1.5 x 75, 2.0 x 75, 2.5 x 75, 3.0 x 75

9 PC. Jogo chaves precisão perfil torx



26.00€
32309PR

- T4 x 40, T5 x 40, T6 x 40, T7 x 40, T8 x 40, T9 x 50, T10 x 50, T15 x 50, T20 x 50



Chave para caixa 4 perfis

11.00€
7HA21



- Anel externo : Ø 11.9 mm
- Anel interno : 6 x 6 mm



- Anel externo : Ø 14 mm
- Anel interno : 8 x 8 mm



- Anel externo : Ø 14 mm
- Anel interno : altura do triângulo 9 mm



- Anel externo : 14 x 9 mm
- Anel interno : Ø 5.5 mm



SL bit 1.0 x 7mm & PH2 bit

Adaptador para bits
1/4"



REFª	mm	mm	mm	No.	mm		
7HA21	6,8	9	3-5	PH2	1.0 x 7	89	20 / 200



Ferro de soldar estanho

- 110V~240V, 30W, 40W, 60W, 100W
- Para trabalhos elétricos e vitrais

- Alça leve
- Ponta substituível
- Sem certificação CE

REF ^o	Volts	Avanço	Alça	€
6BC23A	220-240	30	160	10.00
6BC24A	220-240	40	125	10.00
6BC26A	220-240	60	166	12.00
6BC210A	220-240	100	210	23.00



6BC



6BC210



6BC23 / 6BC24 / 6BC26

BOMBA DE DESSOLDAR

- Compr. total: 197 mm

7.00€

6BD22



• Baixe o corpo

• Limpe

• Vire o corpo

Multímetro digital

CE



62.00€

9DM1361

- Une com : 500mA / 660V & 10A / 600V
- CE aprovação IEC61010-1 (2010), CAT.II 600V, CAT.III 300V
- Especificações:

DC Voltagens (0.1mV ~ 1V)	00mV / 2V / 20V / 200V / 600V
AC Voltagens (0.001V ~ 1V)	2V / 20V / 200V / 600V
DC Ampere (0.1uA ~ 0.01A)	200uA / 2000uA / 20mA / 2A / 10A
AC Ampere (0.1uA ~ 0.01A)	200uA / 2000uA / 20mA / 2A / 10A
Resistência (0.1Ω ~ 0.01MΩ)	200Ω / 2kΩ / 20kΩ / 200kΩ / 2MΩ / 20MΩ
Verificação de continuidade	Sim
Teste de iodo	Sim
hFE(NPN, PNP)	Sim
Indicador LED	Sim
Indicador Bateria Fraca	Sim
Mostrador LCD	3 1/2 contador de 2000 dígitos

CE

Pinça amperimétrica

CE



118.00€

9DM2351

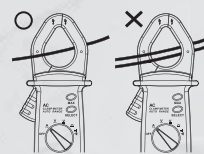

- Tam. máximo: Ø 30mm
- Unidade & função de indicação, o valor máximo de leitura de 1999 dígitos
- Indicador de polaridade negativa (nenhuma indicação é dada para polaridade positiva)
- Desliga automaticamente depois de 15 minutos
- Baixo consumo de energia
- CE aprovação IEC 61010-1, IEC 61010-2-032 CAT.III 600V Grau de poluição 2
- Cabos de teste anexados, operação fácil
- Especificações:

AC Ampere (0.1A - 1A)	200A / 600A
AC Voltagens (0.001V - 1V)	2V / 20V / 200V / 600V
DC Voltagens (0.1mV - 1V)	200mV / 2V / 20V / 200V / 600V
Resistência (0.1Ω - 0.01MΩ)	200Ω / 2kΩ / 20kΩ / 200kΩ / 2MΩ / 20MΩ
Verificação de continuidade	Sim
Teste de iodo	Sim
Indicador Bateria Fraca	Sim
Mostrador LCD	3 1/2 dígitos 1999
contagens	
Taxa de Amostragem	3 / Sec.
Indicador de sobrecarga	OL

9 em 1 Descarnador de fios multifunções

- Detecção de tensão sem contato 80 - 1000V, 3 minutos de desligamento automático
- Aplicação: Tensão AC em tomadas, iluminação, disjuntores, fios e cabos, etc.
- Iluminação: LED COB
- Almofadas magnéticas que podem ser úteis para segurar pequenos componentes como porcas e parafusos
- Chave de fenda nº PH2 x1
- Bateria: 3V (AAA 1,5V x2) Incluída
- Categoria padrão: CAT IV 1000,
- EN 61010-1: 2010/A1: 2019, EN 62471: 2008,
- EN 61326-1: 2013, EN 61326-2-2: 2013



• Decapador (cabo romex tipo NM-B)



• Decapador



• Decapador



• Magnético



• Fecho



• Volt testador



• Medidor



• Chave de fenda (Use 65mm-70mm)



• Corte

66.00€

6CB41



Interruptor

Interruptor de teste

REFª	Decapador de fios	Decapagem cabo romex	Descapagem redondo	cabo Ø mm	cutador de fio Ø mm	⚖️	📦
6CB41	mm ² -0,5, 0,8, 1,3, 2,0, 3,3, 5,0, 8,0 AWG-20, 18, 16, 14, 12, 10, 8	12~2	8~10	7	220	1 / 50	



AC Testador de corrente sem contato

- Faixas de tensão: 80 a 1000 V CA. (50 ~ 60 Hz)
- Aplicação:
- Tensão AC em tomadas, iluminação, disjuntores, fios e cabos etc.
- Detecção de tensão de sensibilidade ajustável
- Indicador de tensão de luz LED visível na ponta (luz verde é marcha alta, luz vermelha é marcha baixa)
- Bateria AAA x 2 PC. incluído
- Categoria padrão: EN 61000-6-3 / EN 61000-6-1 CAT III
- Total Tam. (mm): 160(L) x 20(L) x 24(A)

57.00€

6CB31



Testador corrente 6-24V

- Comprimento : 107 mm

5.80€

9DC22



Chave de fendas de teste

• Alcance teste : 100~500V



1.88€

6CB02



Voltímetro



- Aprovação CE
- Teste de tensão DC : 12, 24, 50, 120, 230, 400, 690V
- Teste de tensão AC : 12, 24, 50, 120, 230, 400, 690V
- Indicação de alta tensão $\geq 50V$
- Alcance de frequência: 0-70Hz
- Teste de continuidade : 0~550K Ω
- Teste de autodiagnóstico
- Condição de operação : -10~55°C
- AAA 1.5V x 2pcs

71.00€

6CB21



Tesoura eletricista 145 mm

11.00€

6AB12-55



Flo Elétrico	Cartão	Capacidade corte (mm)		Aço Lamina	Cobre mole	Alumínio
		Borracha	Couro			
10	10	10	10	0.5	0.5	0.5

Tesoura eletricista

22.00€

6AB13-06



Comprimento mm	Capacidade corte mm	Capacidade corte AWG	Capacidade corte mm ²
150	26	2	38

5 em 1 Tesoura electricista

24.00€
6AB14-06

1/0
AWG

50
mm²



• Terminal de crimpagem do cabo

• Raspagem



• cabo de soldadura 100mm²

• Decapador de fios 1.5-4mm²



REF ^o	Compr. total: polg. mm	Compr. de corte mm	Capac. de corte AWG mm ²	Decapador de fios AWG mm ²	Pem term. isolado/ Crimpagem de term. não isolados AWG mm ²	193	12 / 48
6AB14-06	6-3/8 161	24	1/0 50	14, 12 1.5, 2.5	14 2.5		

29.00€
6AB14-65

3/0
AWG

80
mm²



• Decapador de fios 1.5-4mm²

• Terminal de crimpagem do cabo

• Terminal de crimpagem do cabo



• cabo de soldadura 100mm²

• Raspagem



REF ^o	Compr. total: polg. mm	Compr. de corte mm	Capac. de corte AWG mm ²	Decapador de fios AWG mm ²	Term. isolado/ Crimpagem de term. não isolados AWG mm ²	228	12 / 48
6AB14-65	6-3/4 170	21	3/0 80	16, 14, 12 1.5, 2.5, 4	14 2.5		



Navalha de electricista

• Compr. total: 196 mm



12.00€
7932-04



Faca descarnadora de cabos

• Compr. total: 204 mm

15.00€
7935-08



• Decapagem de cabos



• Raspagem



• Conjunto de proteção bloqueado



• Conjunto de proteção desbloqueado



Canivete com bloqueio da lâmina

• Compr. total: 210 mm

22.00€
7941-08

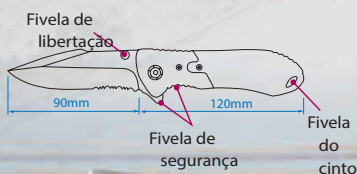

2 em 1 - X-acto lâmina dupla

13.00€
7945-07



• Compr. total: 171 mm



7945-07P01
(62mm, 10 PC.)

7945-07P02
(48mm, 10 PC.)

X-acto corta cintos de segurança

• Compr. total: 180 mm

14.00€
7946-07



7945-07P01
(62mm, 10 PC.)

• Botão de retorno automático



• Botão de bloqueio automático



• 2 lâminas no armazenamento



• Botão de substituição da lâmina

X-Ato 7" com lâminas 18mm

13.00€
7971-07



X-acto

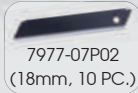

6.50€
7977-07



X-acto recarregamento automático

4.00€
7978-07



- Remove rapidamente a lâmina e recarrega automaticamente
- Armazenamento de 3 lâminas

7978-07P02
(18mm, 10 PC.)

Alicate descarnar automático



26.00€
6761-07

REFª	Decapador de fios mm ²	Compr. total:mm		
6761-07	0.9, 1.25, 2, 3.5, 5.5	178	271	10 / 60

Descarnador de cabos

- Descarnagem rápida e segura de bainhas de cabos redondos em PVC ou borracha de Ø 6-45 mm
- Porca serrilhada ajustável para bainha máxima de 6 mm

33.00€
67B3-55



- Profundidade de corte ajustável



- Tampa de empurrar



- Rotação simples do corpo da ferramenta

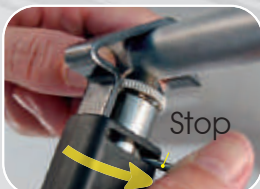

- Remove as bainhas dos cabos sem danificar os condutores internos



Alicate cravar multi-funções 7 em 1

44.00€
67BA1-08

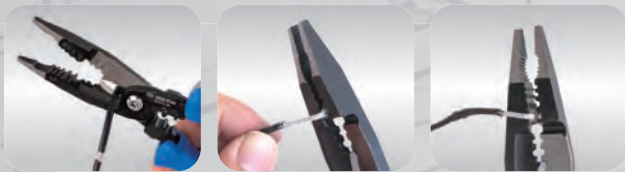

- Corte
- Decapagem
- Crimpagem



REF ^º	Wire cutter	Decapador de fiosmm ²	Crimping Capacid. mm ²		
67BA1-08	Ø15mm 50 mm ²	0.7-1.5/2.5	0.5-2.5	0.28	6 / 60

Alicate de Cravar

30.00€
6721-10



FUNÇÃO:

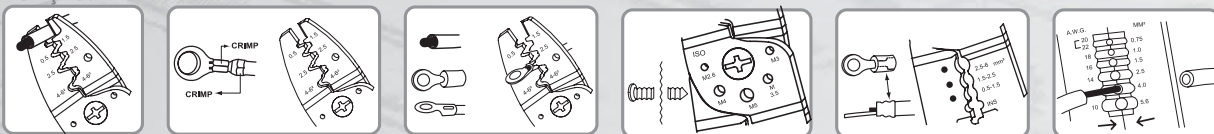

- Corta fio
- Crava terminais abertos
- Crava terminais não isolados
- Corta parafusos
- Crava terminais isolados
- Decapa fio

REF ^º	Corta fio Ø mm ²	Crava terminais abertos	Corta parafusos	Crava terminais não isolados	Crava terminais isolados	Decapa fio mm ²
6721-10	6	0.5~6	M2,6~5	0.5~6	1.5~6	0.75~6.0

Alicate cravar terminais não-isolados com roquete

34.00€
6AC52-12

- Para terminais não isolados
- Compr. total: 300 mm



	AWG	16	14	10	8	6
REF ^º	JIS mm ²	1.25	2	5.5	8	14
	DIN mm ²	1.5	2.5	6	10	16
6AC52-12		•	•	•	•	•

Alicate de cravar para pesados 665mm L

148.00€
6AC51-26



Capacidade de cravar

AWG	8	6	4	2	1/0	2/0	3/0	4/0	300MCM
JIS(mm ²)	8	14	22	38	60	70	80	100	150
DIN(mm ²)	10	16	25	35	50	70	95	120	150

7 PC. Jogo de alicates de cravar



128.00€
42107GX

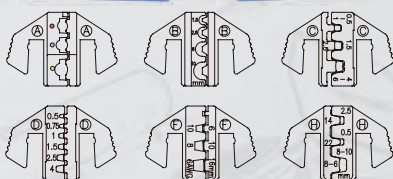

CONTEÚDOS:

- A : Terminal isolante : 0.5 to 6mm²
- B : Terminal não-isolante : 1.5 to 10mm²
- C : Terminal aberto barrilado : 0.5 to 6mm²
- D : Terminal isolado fim de núcleo : 0.5 to 4mm²
- F : Terminal isolado de núcleo : 6 to 16mm²
- H : Abertura barrilada & conectores, V.35 : 0.5 to 10mm²

Alicate cravar fichas de rede

- Para cortar / decapagem / crimpagem
- 2 tipos de plugues em 1 ferramenta
- Material de aderência - PP+TPR
- Compr. total: 203 milímetros



• 6P

• 8P

39.00€
67F1-08

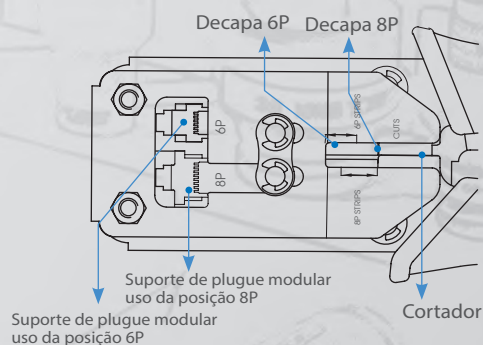

MARTELOS E FERRAMENTAS



Martelo com batentes Poly (Substituíveis)

36.00€
7842-45

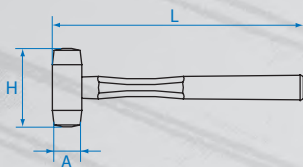

REF ^o	A mm	H mm	L mm	
7842-45	45	112	335	420



Martelo anti-recuo 1134 Grs

27.00€
7851-40

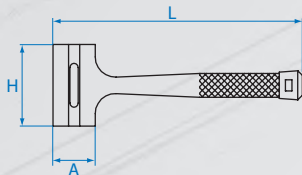

REF ^o	H.W g	A mm	H mm	L mm	
7851-40	1134	58	110	342	1168



Punção de centrar automática

- Ø 1.7 mm
- L : 155 mm

10.00€

76804-05

15.00€

76807-06

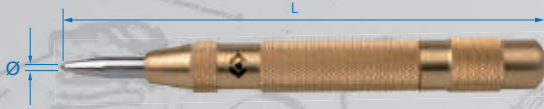

4 PC. Jogo de escopos nervurados

- Cinzel Plano: 17 x 125, 20 x 150, 25 x 200, 29 x 250

44.00€

11104PR10



Numerário de pancada 5.0mm

20.00€

11509SQ05



Abecedário de pancada 5.0mm

59.00€

11527SQ05



REF ^o	Tam. mm	Poleg.	Conteúdo	Haste m ²	L mm	
11509SQ05	5.0	3/16"	9 PCS 0~9	11	61	0.56
11527SQ05	5.0	3/16"	27 PCS A~Z, &	11	61	1.70

Extrator de 2 garras



7962

REFª	A mm	€
7962-03	75	16.00
7962-04	100	28.00
7962-06	150	48.00
7962-08	200	87.00
7962-12	300	243.00

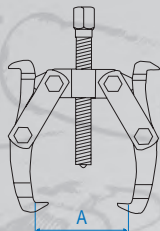

Extrator de 3 garras



7963

REFª	A mm	€
7963-03	75	23.00
7963-04	100	38.00
7963-06	150	71.00
7963-08	200	132.00
7963-12	300	311.00

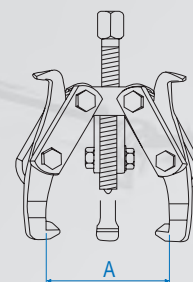

Extrator de 2 garras

7962B

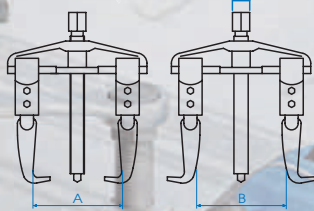

REFª	A mm	B mm	€
7962B-35	90	125	65.00
7962B-05	130	160	70.00
7962B-06	150	200	108.00
7962B-08	190	230	112.00
7962B-10	240	300	196.00

Extrator de rolamentos dos alternadores



75.00€
7965-02



• Ajuste as garras girando o parafuso

REFª	Capacd. (Tons)	Ext.A(mm)	Alcan. B(mm)	⚖️
7965-02	2T	19-45	73	905

6 PC Expositor de extratores de 2 garras

- Extrator de engrenagem de duas garras
- Braço deslizante ajustável para eficiência e segurança
- Mordentes reversíveis para opções internas e externas de engrenagens, eixos, rolamentos, etc...

Conteúdo

⚖️ 18.20 📦 1



7962B 3.5", 5", 6", 8", 10"

87155

584.00€
7962B1PR



5 PC. Jogo de chaves de extração



11.50€
11205SQ

Conteúdos

2127-06M	1/8"-1/4"
2127-08M	1/4"-5/16"
2127-11M	5/16"-7/16"
2127-14M	7/16"-9/16"
2127-18M	9/16"-3/4"

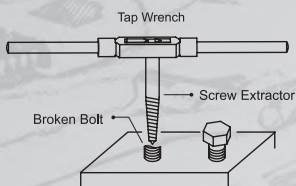

25 PC. Jogo de brocas e extrator

- Fácil de remover os parafusos quebrados de 5 a 14 mm
- 15 PC. Broca HSS e guia central
- 10 PC. pino e porca extrator

79.00€
11225SQ



- Use o guia para perfurar um orifício piloto no centro parafuso partido

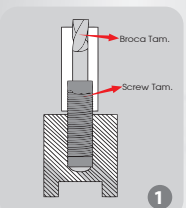

- Coloque a porca extrator para fora do parafuso partido com a chave

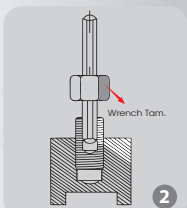

119 PC. Jogo reparação de roscas



165.00€
11311MO

119 PC. Jogo machos e caçonetes



103.00€
12939MO1



Descravador de correntes



3214

REF ^o	Corrente Tam. ANSI NO.		€
3214-35	35~50	310	22.00
3214-60	60~100	691	37.00

Faca para limpeza e remoção de silicones

- Compr. total: 204 mm
- Tam.: 3R, 6R, 10R, 13R, 17R



13.00€
7AA105



- Inclui cinco cabeças de almofada de bico diferentes

7 PC. Ponteira para aplicação de silicones - para aplicar nas pistolas

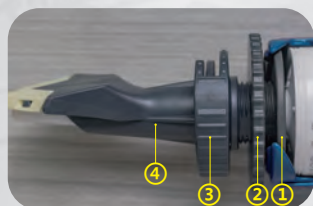

Como instalar:

1. Base rosqueada
2. Anel de retenção
3. Adaptador
4. Cabeça da almofada do bocal

- Tam.: 3R, 6R, 10R, 13R, 17R



12.00€
7AA107

Pistola para aplicação silicone - cartuchos 310ml



- Porca ajustável

29.00€
7CA81-30H

- Compr. total: 357 mm

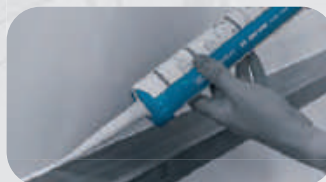

Pistola para aplicação silicone - cartuchos 310ml, corpo em alumínio

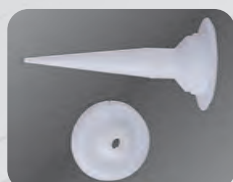

32.00€
7CA82-30

- Compr. total: 352 mm



Tesoura corte de chapa

- CRMO especial forjado com bordas endurecidas por indução 62HRC
- Lâminas com bordas serrilhadas cortes rápidos em chapas de metal, alumínio e muito mais
- Cortar aço de baixo carbono laminado a frio de 1,2 mm (18GA)
- Apertos de código de cores antiderrapantes para controle superior



740

74010



74020



74030

REFª	Compr. total:mm	Corte compr.mm	Cor do punho	(suave)	Capacidades de corte (mm)			Scales	€
					Cobre	Aço laminado a frio (suave)	Aço duro HRC 30 (duro) aço304		
74010	248	35	Red	1.50	1.20	0.80	0.70	375	16.00
74020	248	35	Green	1.50	1.20	0.80	0.70	375	16.00
74030	250	38	Yellow	1.50	1.20	0.80	0.70	380	16.00

Tesoura corte de chapa 10"

- Gota forjada de bordas endurecidas por indução de aço de melhor qualidade 60HRC
- Corta a ferramenta de guias de face plana reta ao longo da linha reta
- Lâminas individualmente afiadas manualmente para máxima eficiência de corte
- Alça de almofada para conforto e melhor aderência

18.00€
74410



REFª	Compr. total:mm	Corte compr.mm	Copper (soft)	Cold-rolled Steel (soft)	Capacidades de corte (mm)		Scales
					Hard steel HRC 30 (Hard)	Stainless steel304	
74410	254	51	0.94	0.78	0.60	0.45	480

Apalpa-folgas 25 lâminas métricas

Conteúdo :

- 0.04, 0.05, 0.06, 0.07, 0.08, 0.09, 0.10, 0.15, 0.20, 0.25, 0.30, 0.35, 0.40, 0.45, 0.50, 0.55, 0.60, 0.65, 0.70, 0.75, 0.80, 0.85, 0.90, 0.95, 1.00 mm

12.00€
77335-25



Apalpa-folgas 26 lâminas polgadas

Conteúdo :

- 0.0015", 0.002", 0.0025", 0.003", 0.004", 0.005", 0.006", 0.007", 0.008", 0.009", 0.010", 0.011", 0.012", 0.013", 0.014", 0.015", 0.016", 0.017", 0.018", 0.019", 0.020", 0.021", 0.022", 0.023", 0.024", 0.025"
- 0.038, 0.051, 0.063, 0.076, 0.102, 0.127, 0.152, 0.178, 0.203, 0.229, 0.254, 0.279, 0.305, 0.330, 0.356, 0.381, 0.406, 0.432, 0.457, 0.483, 0.508, 0.533, 0.559, 0.584, 0.610, 0.635 mm

9.00€
77328-26



Iluminação



Lanterna recarregável

Lanterna fina de inspeção

CE



55.00€
9TA261A



45.00€
9TA263

- LED COB 6W + 1 LED
- Alternar modos:
- Luz superior-120 lúmen
- Luz de trabalho de baixo 250 lúmen
- Luz de trabalho com 600 lúmens
- Materiais: Caixa em plástico ABS + borracha + lente PC + caixa fina em alumínio
- Rotação de ângulo de 120° e base magnética
- Bateria recarregável: 3.7V - 2600mAh Li-ion
- IP54 à prova de água

- 2W COB + 1.5W COB + 1W SMD
- Mudar de modo:
- Luz superior - 80 lúmen
- Luz principal baixa / alta - 100/200 Lumen
- Luz lateral -180 lúmen
- Material: PA + Alumínio
- Base magnética forte + cabeça giratória de 180°
- Bateria recarregável: 3.7V - bateria de Li-ion 700mAh
- IP54 à prova d'água e poeira
- IK07 à prova de vandalismo

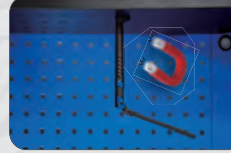

2PC. 2W + 5W - Gambiarras inspeção

65.00€

P9TA0212

- 2W COB + 1W LED
- Cor da luz branca, kelvin: 6500K
- Modelo do interruptor: Luz superior – 30 lúmens (lm) / 4 horas Luz principal baixa / alta – 100 / 200 lúmens (lm) – 3 / 1,5 horas
- Material: ABS e PC
- Rotação giratória de 180° + cabeça giratória de 360°
- Clipe magnético e base
- Bateria recarregável: 3,7V 800mAh Li-ion
- Acessório: Tipo – C Cabo de carregamento USB
- LED de status da bateria e indicador de carga
- Tempo de carregamento: 1,5 horas



- 5W COB + 1W LED + 1W UV
- Cor da luz branca, kelvin: 6500K
- Modelo do interruptor: Luz superior – 30 lúmens (lm) / 11 horas. Luz principal baixa/alta – 250/500 Lumen (lm) – 3/1,5 horas de luz UV
- Material: TPR e PC
- Rotação giratória de 180° + cabeça giratória de 360° +
- Gancho escondido + base magnética forte
- Bateria recarregável: 3,7V 2200mAh Li-ion
- Acessório: Tipo – C Cabo de carregamento USB
- LED de status da bateria e indicador de carga
- ícone indicador de modo
- Saída USB 5V1A como banco de potência móvel
- Tempo de carregamento: 3 horas

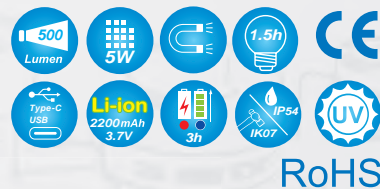

• Top SMD



• Clipe magnético e base



• Cabeça giratória 360°



• Tipo - porta USB C



• Cabeça giratória 360°



• luz UV



• ícone indicador de modo



• Porta USB de E/S (Tipo-C)



2PC. Lanterna cabeça + Lanterna tipo caneta recarregável

48.00€
P9TA5002

- 1.5W COB
- Cor da luz branca, kelvin: 6500K
- Modelo do interruptor: Pouca luz – 100 lúmens (lm) / 4 horas. Luz principal – 200 lúmens (lm) / 2 horas
- Modo de detecção: 200 lúmens (lm) / 2 horas
- Pressione o botão liga / desliga por 3 segundos para ligar o modo de detecção;
- Pressione o botão liga / desliga 3 vezes para desligar o modo de detecção
- Material: ABS de alto impacto + carcaça TPE + lente PC
- Sensor de movimento inteligente de 10 cm, base de ângulo ajustável de 40 °
- Bateria recarregável: 3,7V 600mAh Li-ion
- Acessório: cabo de carregamento micro USB de 1 m
- LED indicador de carga da bateria
- Tempo de carregamento: 2,5 horas



9TA521

+

- 3.5W-7 SMD + 1W SMD (Top)
- Cor da luz branca, kelvin: 6500K
- Modelo do interruptor: Luz superior: 80 lúmens (lm) / 4 horas. Luz principal: 120 Lumen (lm) / 2,5 horas
- Material: carcaça ABS + pintura emborrachada + lente PC
- Ímã forte no clipe
- Bateria recarregável: íon de lítio 3,7V 750mAh
- LED indicador de carregamento: Vermelho -Em carga, Verde -Carregado
- Tempo de carregamento: 2 horas



9TA281



40°

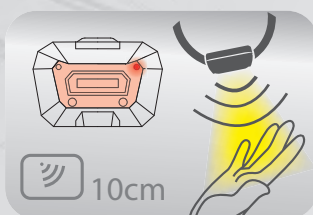

10cm



10W COB Lampada LED de trabalho

56.00€
9TA33A

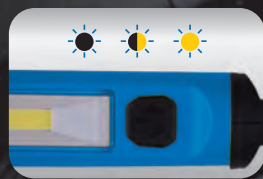

3W COB + 5 Lanterna LED



31.00€
9TA27A



- 3W COB + 5 LEDs
- Materiais: ABS + PS
- Base giratória magnética de 180° + gancho funcional de 360°
- Bateria recarregável: 3.7V - 2600mAh Li-ion
- IP20 à prova de água e poeira
- IK07 à prova de choque

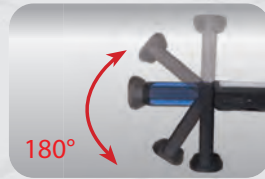

1.5 W COB + 1 Lanterna LED recarregável



17.00€
9TA28



Clipe magnético giratório

- 1.5W COB + 1W LED
- Materiais: ABS + PC
- Brilho: 145 lúmen
- Base giratória magnética 180° + clipe giratório magnético 270°
- Bateria recarregável: 3.7V - 800mAh Li-ion



5W COB LED + 1 LED - Gambiarra inspeção flexível

- 5W COB + 3W SMD (Top)
- White light color, kelvin : 6000K~6500K
- IP54 waterproof and dustproof, IK07 vandalproof
- Switch Mode :
Top light -120 Lumen(lm) / 9 hours
Main light - Stepless Dimmer Switch :
Min ~ Max - 50 ~ 500 Lumen(lm) / 16 ~ 2 hours
- Material : PA + TPE housing
- Flexible Gooseneck + 90° hiding hook + Strong magnetic base
- Rechargeable battery : 3.7V - 2600mAh Li-ion battery
- Accessory : 1m Micro USB charging cable and 5V 1A USB charger
- Three leds battery indicator
- Charging time : 4 hours

79.00€
9TA251A



CE
RoHS



• Top SMD



• USB charger port + battery indicator



• Strong magnetic + 90° Hook



• Stepless Dimmer Switch



7W COB LED + 1 LED - Gambiarra de bolso

- 7W COB LED + 3W SMD
- Cor da luz branca, kelvin: 6500K
- IP20 à prova d'água e poeira, IK07 à prova de vandalismo
- Modo de comutação:
- Holofote - 250 lúmens (lm) / 4 horas
- Pouca luz - 120 Lumen (lm) / 12 horas
- Luz média - 350 Lumen (lm) / 5 horas
- Luz alta - 700 Lumen (lm) / 2,5 horas
- Material: Caixa e lente duráveis
- Cabo flexível de 180° + imã super forte no cabo
- Bateria recarregável: bateria de íons de lítio de 3,7 V - 2600 mAh
- Acessório: Cabo de carregamento USB tipo C
- 3 LEDs indicadores de status da bateria
- Tempo de carregamento: 4 horas

62.00€
9TA44A



RoHS



• LEDs indicadores de status da bateria



• Direção flexível de 180°



• Ímã super forte na alça



7W COB LED + 1 LED - Gambiarra de bolso (carregamento wireless)

- 8W COB LED + 3W SMD
- Cor da luz branca, kelvin: 6500K
- IP65 à prova d'água e à prova de poeira, IK07 à prova de vandalismo
- Modo de comutação:
- Holofote - 250 lúmens (lm) / 4,5 horas
- Pouca luz - 160 Lumen (lm) / 10 horas
- Luz média - 400 lúmens (lm) / 4,5 horas
- Luz alta - 800 Lumen (lm) / 2,5 horas
- Cabo flexível de 180° + imã super forte no cabo
- Bateria recarregável: bateria de íons de lítio de 3,7 V - 2600 mAh
- Acessório: Cabo de carregamento rápido USB Type-C
- 3 LEDs indicadores de status da bateria
- Tempo de carregamento: 4 horas por cabo USB, 6-7 horas por base de carregamento sem fio (não incluído, o tempo de carregamento depende da mudança de potência da base de carregamento sem fio)

84.00€
9TA44W



RoHS



• LEDs indicadores de status da bateria



• Direção flexível de 180°



• Ímã super forte na alça



• Fácil de transportar



• Carregamento sem fio



Tripé ajustável para holofote

- Pode conter uma ou 2 luzes (com T-Bar)
- Corpo de tripé de aço resistente durável
- Tubo de três seções Ø: 25mm / 32mm / 38mm
- Altura ajustável do tripé de 700mm a 1500mm
- Portátil, fácil de dobrar e ótimo para transporte
- Recomenda-se usar com 9TA42 / 9TA44 / 9TA45 / 9TA46 (Este produto não contém lâmpadas)



29.00€
87162



Suporte extensível com ganchos para fixação no capô (sem gambiarras)

- Duas bases móveis para todos os tipos de luzes magnéticas
- Base giratória horizontal de 360° para diferentes ângulos de iluminação
- Ajuste de comprimento de três seções
- Corpo de alumínio resistente e durável + PA
- Alça de fecho antideslizante
- Recomenda-se usar com 9TA44 (Este produto não contém lâmpadas)

81.00€
87163

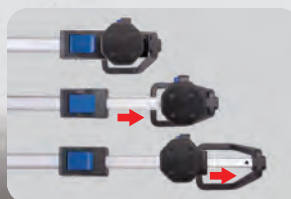
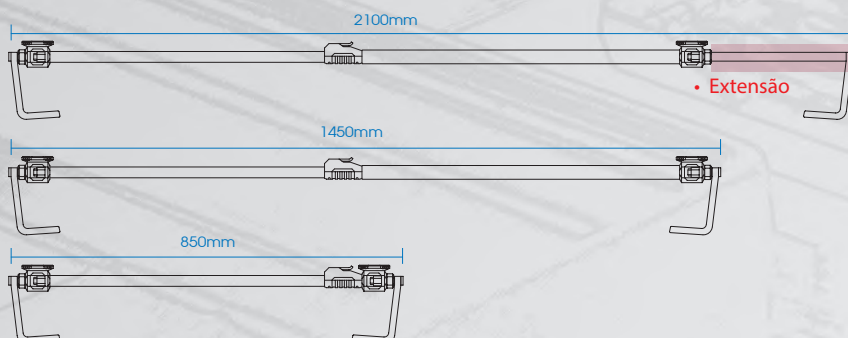

- Ajuste de comprimento de três seções para várias ocasiões

- Base giratória horizontal de 360° para diferentes ângulos de iluminação



Ferramentas de Oficina



Retificador de cilindros 50-175 mm



33.00€
9AC231-54

9AC2315DK

Jogo Universal para alinhamento de embraiagem Ø 15.5~27

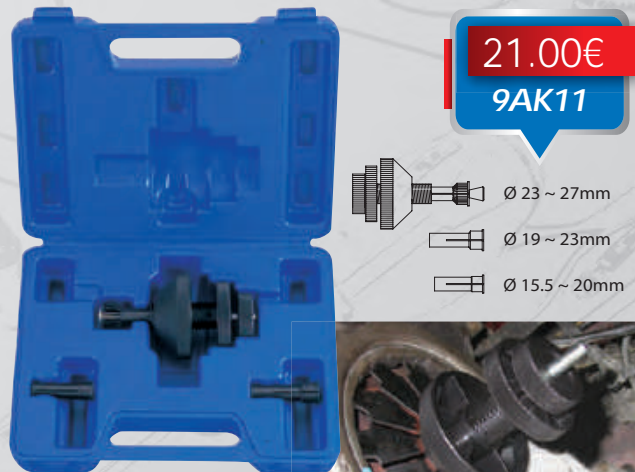

21.00€
9AK11

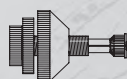
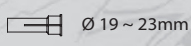
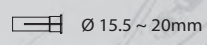
-  Ø 23 ~ 27mm
-  Ø 19 ~ 23mm
-  Ø 15.5 ~ 20mm

Barra retificadora de blocos e cabeça dos cilindros

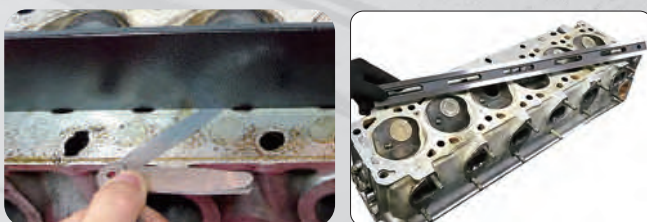

170.00€
9AH41

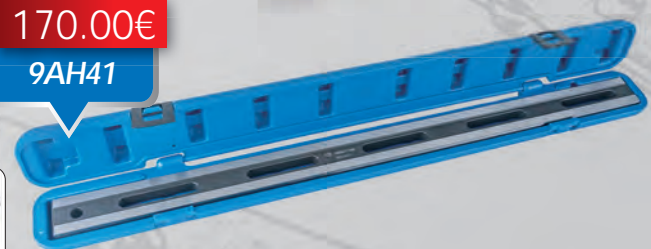

- Adequado para motores de 4 e 6 cilindros
- Consulte o manual de serviço do fabricante automóvel para a folga mínima
- Tam. : 600(L) x 36(W) x 16(H) mm



3 PC. Jogo de alicates fixador mangueiras

19.00€
9AF113

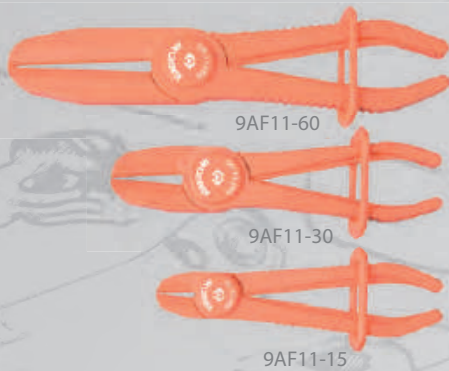

- Para mangueiras de $\varnothing 15$ mm a $\varnothing 60$ mm

Kit 4 peças anti vazamento

21.00€
9AF204



- Capacidade :
Banjo, 1/2"(12.7mm), 3/8"(9.5mm) and
5/16"(8mm)



Ferramentas para desmontar bomba de combustível 89-170 mm

60.00€
9AG11



Rodador de válvulas oscilante

40.00€
9AH0331

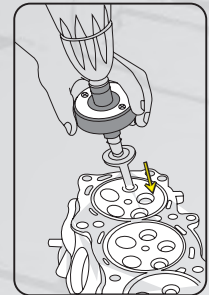

Jogo de molas e válvula compressora

60.00€
9AH31

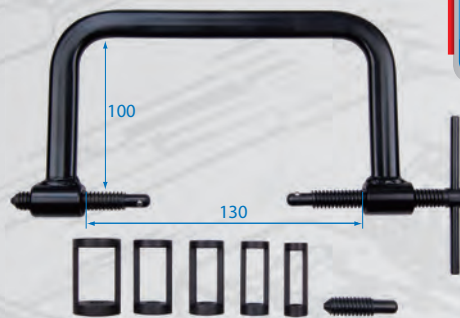

7 PC. Jogo de chaves lambda para sensores de oxigênio

73.00€
9AJ017



Chave para remover e ajustar tampa da bomba de combustível

- Para remover e encaixar os colares do sensor do medidor de combustível para evitar danos
- 4 pinos para garantir alto torque e nenhum risco de danificar o colar de plástico
- Adequado para BMW F01/F02/F25, X3 etc...

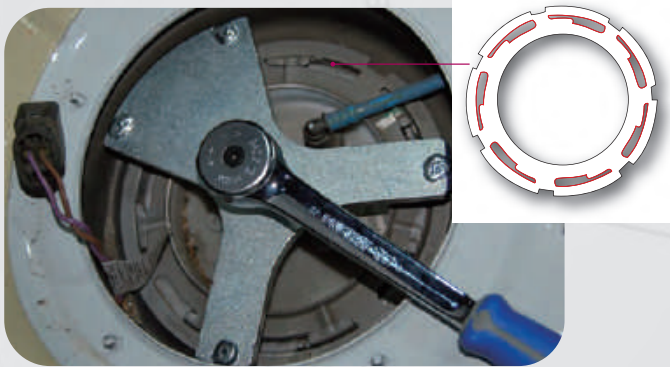

209.00€
9AG12



Chave de correia



25.00€
3203A0

• Ø : 60~260



Chave de corrente



47.00€
320540

• Ø : 60~105 mm

50.00€
320560

• Ø : 60~160 mm



Chave de corrente



15.00€
3204

• Ø 60~140



Giratório



Extrator de injetores a diesel



98.00€
9AN021

Ferramenta de bloqueio do eixo das válvulas e Bomba de injeção



48.00€
9AT3-A01

Chave quadra dupla para bujões de óleo 8x10 mm

- Material : Liga de aço cromo vanádio
- Para bujão de óleo
- Compr. total: 230 mm

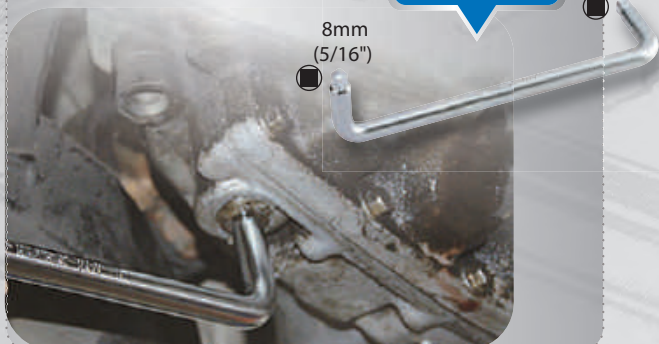

7.00€
1586-09

10mm
(3/8")

8mm
(5/16")

7 PC. Teste universal fugas radiadores

- Cones de borracha com Ø funcional 17~40mm

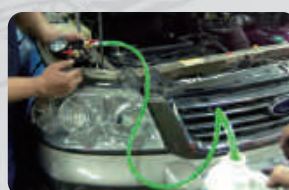

332.00€
9AM012

21 PC. Chaves de caixa para bujão de óleo



61.00€
9AR11

Chave filtros óleo dois braços ajustáveis

9AE52

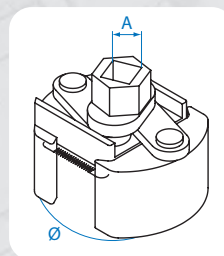

- Conteúdos:
- Chaves de Caixa Hexagonal : H8, H9, H10, H12, H13, H14, H17 mm
- Chaves de Caixa Quadrado : 5/16", 3/8", 7, 8, 10, 11, 12, 13, 14 mm
- Chaves de Caixa TORX : T45
- Chaves de Caixa Triangular : 10mm
- Chaves de Caixa Spline : M16
- Encaixes: 10mm
- 3/8" drive Cabo em T

REF ^{ca}	A Poleg.	Ø Capacd. polg.	mm	g	€
9AE52	1/2	2-3/8~3-1/8	60~80	470	68.00
9AE52-110	1/2	3-1/8~4-5/16	80~110	985	118.00

Alicate para aplicação de segmentos

- Para remover e montar anéis de pistão
- Niquelado



9AP

REF ^o	L polg.	mm	Ø Capacid. mm	Escalas	€
9AP100	8-11/32	212	50~100	323	23.00
9AP120	8-15/16	227	80~120	354	25.00
9AP160	9-61/64	253	110~160	458	28.00

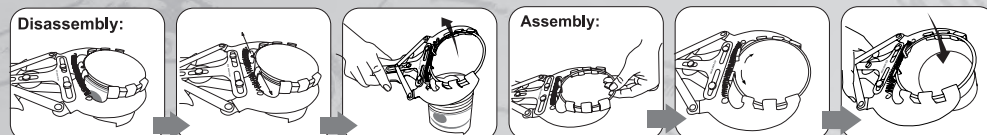
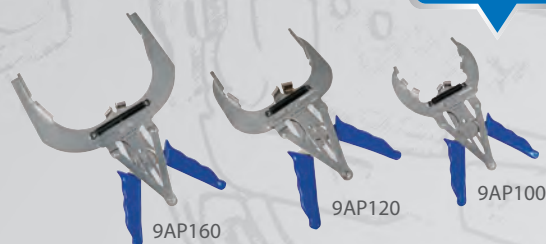

Cinta para aplicação de segmentos

9AC

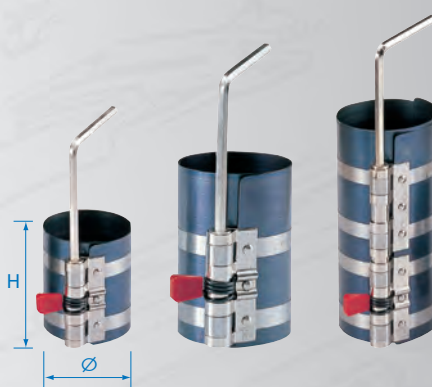

REF ^o	H polg.	mm	Ø Capacid. polg.	mm	Escalas	€
9AC125-32	3-1/4	80	2-1/4~5	57~125	260	15.00
9AC125-40	4	100	2-1/4~5	57~125	280	15.00
9AC175-32	3-1/4	80	3-1/2~7	90~175	300	16.00
9AC175-40	4	100	3-1/2~7	90~175	320	17.00
9AC175-66	6-3/4	165	3-1/2~7	90~175	530	30.00

Chave para filtros cinta em aço

- Banda de metal ajustável
- Adequado para filtros entre Ø65mm a Ø155mm



9AE32

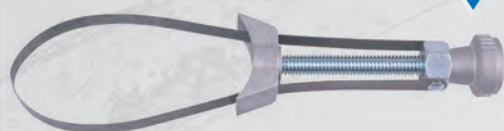

REF ^o	Ø Capacid. mm	Escalas	€
9AE32-110	65~110	246	12.00
9AE32-155	110~155	252	12.00

Chave para filtros cinta em aço 65-110 mm - Ajuste rápido

- Aperto de ajuste rápido
- O tipo de banda permite espaço estreito
- A reação antiderrapante dos dentes proporciona melhor aderência



- O design oferece uma força de fixação mais forte



20.00€
9AE33-110



Chave caixa 1/2" para parafuso braço suspensão traseiro HONDA CRV



2.00€

9BW4801



Chave caixa 1/2" para parafuso cabeça domotor NISSAN - Ribe M12S



2.00€

9AW4901

Chave caixa 1/2" para parafuso do esticador de correia TOYOTA - Ribe M10S



2.00€

9AW4911

18 PC. Kit de ferramentas para embolo do travão



170.00€

9BC25

31 PC. Jogo universal p/ discos de travão



204.00€

9BC23

- Conteúdo:
- 21 PC. Adaptadores para montagem de travões
- 3 PC. Almofadas de apoio
- 2 PC. Pinça rotativa com DR de 3/8 " (lado direito / esquerdo roscado)
- 2 PC. Chave sextavada: 7, 8mm
- 2 PC. Perfurador: Ø 5.5, 6mm
- 1 PC. Chave sextavada DR 8 mm de 3/8 "



Desbloqueador de rótulas Remove & Instala



63.00€

9BE62

Ø Capacidade(mm):33~42



68.00€

9BE63

Ø Capacidade(mm):42~50



Kit sincronização IVECO (motores diesel de correia)

Conteúdo :

- A - Pino de temporização TDC
- B - pino de bloqueio do volante (2pc)
- C - ferramenta de retenção do tensor



26.00€
9AT2-A01

A B C

Kit sincronização FORD & VAG (motores diesel de correia)

Conteúdo :

- A - ferramenta de travamento do virabrequim (prata / oval)
- B - ferramenta de travamento do virabrequim (preta / redonda)
- C - pinos de bloqueio da árvore de cames (2 unid.)
- D - pino trava da polia tensora
- E - Pino de bloqueio do tensor da correia auxiliar

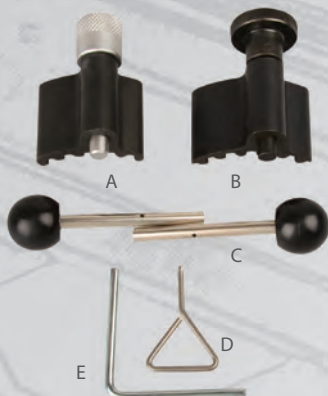

A B

C

D

E

39.00€
9AT2-C01

Kit sincronização RENAULT (motores dCi)

Conteúdo :

- A - Pino de trava do virabrequim
- B - Pino de temporização TDC
- C - Pino de bloqueio da árvore de cames/virabrequim



B

A

C

27.00€
9AT3-A03

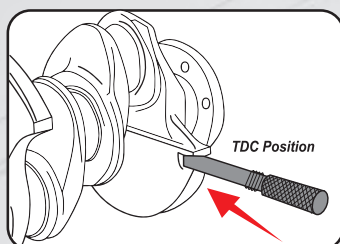

TDC Position

Extrator bomba injeção diesel

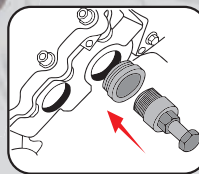

67.00€
9AT2-D01

Kit sincronização OPEL (motores CDTi de corrente)

Conteúdo :

- A - jogo de ferramentas de ajuste da árvore de cames (par)
- B - pino de bloqueio do volante
- C - pino de retenção do tensor



115.00€
9AT2004E

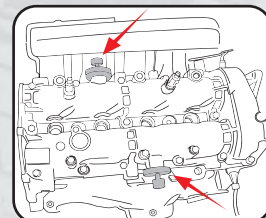
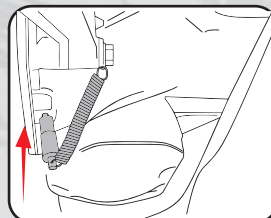

9 PC. Chave fixação da polie do motor

117.00€
9AT3-A02

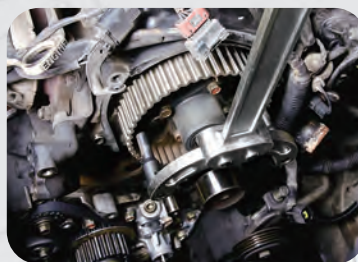

Jogo de saca molas 370 mm



71.00€

9BF11

- Mandíbulas SCM435 forjadas & parafusos chumbados
- Chaves de caixa 21mm e 6 pontos disponíveis
- 1/2" chaves disponíveis

Jogo de molas compressoras p/amortecedores



528.00€

9BF31

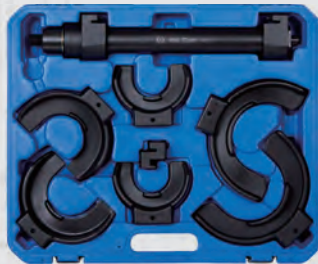

∅ Capacidade(mm):40~300

Alavanca p/ desmontar pneus

9BK41

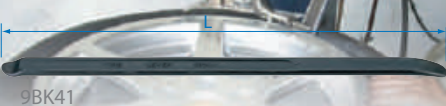

9BK41

9BK43

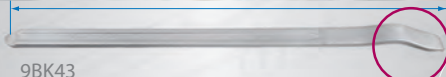

9BK43

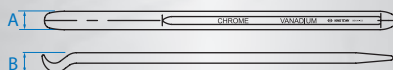

REFª	L poleg. mm	A mm	B mm	∅	€
9BK41-20	8 200	21.6	11	104	6.00
9BK41-28	11 280	22.7	13.5	239	7.00
9BK41-38	15 380	24.5	13.5	358	10.00
9BK41-53	21 530	28	12	928	19.00
9BK41-65	25 650	30	15	1075	27.00
9BK43-65	25 650	30	15	1100	29.00

Alavanca p/ desmontar pneus

75.00€

9BK41-73



REFª	L poleg. mm	A mm	B mm	∅
9BK41-73	28-3/4 730	22	64.4	1618

17 PC. Jogo de extração com barra de impacto

125.00€

9BQ01



Conteúdo:

- 1 PC. Eixo do punho de 500 mm T
- 1 PC. 5 lbs / 2,2 kgs martelo
- 1 PC. Extrator do eixo
- 1 PC. Extrator
- 1 PC. Gancho
- 1 PC. Alicates de bloqueio
- 1 PC. Tira mossas
- 1 PC. Parafuso central

- 1 PC. Cabeça dupla
- 1 PC. Cabeça tripla
- 1 PC. Porca ajustável
- 3 PC. Perna de 3,5 polegadas
- 3 porca de conjunto e parafuso

- Hex 19mm x 5/8" x 18UNF x L140mm



Extrator de rótulas

51.00€

9BE21



Chave removeira de rótulas axiais

109.00€

9BE52



- Remove e substitui rótulas axiais da direção: trabalha com chave 27 mm ou 1/2" DR.
- Comprimento : 400 mm
- Capacidade : ∅35-45 mm



Extrator de himocinética

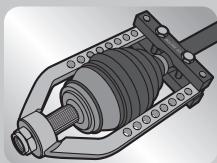

64.00€

9BB42



3 PC. Compressor de molas amortecedores - Interior

478.00€

9BF33



- Pinos especiais no corpo da ferramenta para encaixar nas ranhuras dos discos para criar uma conexão segura



Fig 1 • Coloque os discos superior e inferior na mola



Fig 2 • Insira o corpo da ferramenta principal na mola



Fig 3 • Insira através do disco e gire meia volta para conectar a ferramenta e o disco



Fig 4 • Gire a porca sextavada na extremidade inferior do corpo da ferramenta principal para fixar todas as peças



Fig 5 • Use uma chave de ar/impacto para comprimir a mola



Fig 6

Aplicador de cinta dos foles

43.00€

9BB31



- Comprimento : 124 mm

11" Pistola de sucção de óleo

20.00€

9BT250

- Comprimento : 340mm

27.00€

9BT2100

- Comprimento : 440mm



400cc Pistola de lubrificação c/ tubo 12"

45.00€

9BU1431T

- Comprimento : 267mm
- (Ø)Rosca 10 x 1.0 Metrica



Bomba lubrificação horizontal 400 cc

38.00€

9BU241T

- Comprimento: 360mm
- (Ø)Rosca: 1/8 x 28 PT

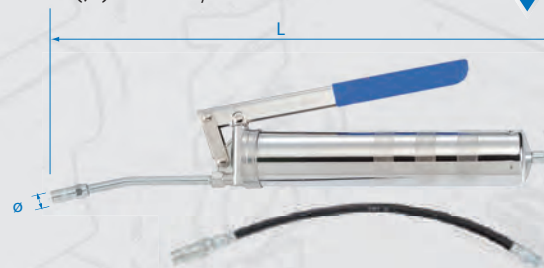

4 PC. Jogo de remoção de pára brisas

CONTEÚDO:

- A - Ferramenta de alimentação de arame
- B - puxador de cabo - par
- C - Fio de corte triangular - 22 metros



54.00€
9CW01

Ventosa dupla para pára-brisas



54.00€
9CW21



Densímetro para líquido das baterias

7.00€
9DD21

- Teste o hidrômetro da bateria rapidamente
- Use para verificar a condição da bateria e o estado da carga
- Detecta sobrecarga quente ou fria com precisão
- Testa todos os sistemas de 6, 12 e 24 volts



Densímetro para anticongelante

7.00€
9DD22

- Use para verificar a condição do anticongelante e refrigerante (Etileno Glicol)
- Ideal para evitar congelamentos no inverno e superaquecimento no verão



Ventosa simples para pára-brisas



18.00€
9CW22



1/2"DR. Ferramenta para polie de alternador 113MM

9.00€
9DA103

9.00€
9DA104



M10(9DA103)



T50(9DA104)

6 PC. Jogo mini removedores de forras PVC

28.00€
9CI016



Videoscópio (Wi-Fi)

- Versão wi-fi
- Antes de usar, baixe o aplicativo inskam, ambos IOS e Android são aplicáveis
- Equipado com bateria de íon de lítio de 1800mAh, pode ser usado continuamente por 4 horas



73.00€
9TQ12



Conteúdo

- Tampa protetora
- Gancho
- Magnético
- Espelho lateral
- Cabo de carregamento

Caneta teste liquido dos travões

32.00€
9DL12

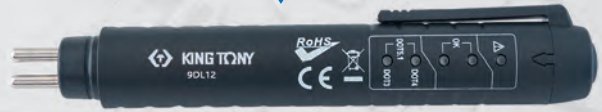

- Pressione e segure o botão On / Off por cerca de 1 segundo para alternar a categoria do Liq. de travões
- DOT3: LED azul inferior
- DOT4: LED azul superior
- DOT5.1: LEDs azuis duplos



- A energia da bateria é suficiente / O Liq. de travões não contém água

- LED amarelo, baixa percentagem de água Verifique novamente dentro de 6 meses

- LED vermelho, troque o Liq. de travões

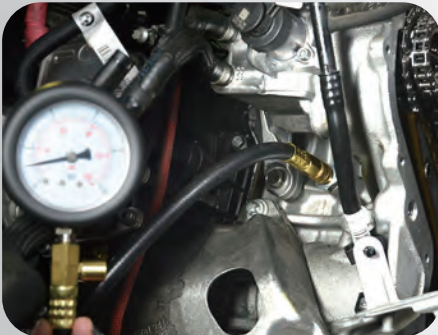

13 PC. Teste pressão óleo do motor

151.00€
9DP3201

Adaptador

Preto (Rosca Imperial)	Prata (roscas métrica)
1/2" x 20 UNF	M10 x P1.0
3/8" x 20 UNF	M12 x P1.5
1/4" x 18 NPTF	M14 x P1.5
1/8" x 27 UPT	M16 x P1.5
R 1/8" DIN	M18 x P1.5



89.00€

9DC51

Equipamento teste de baterias 12V

Faixa de configuração disponível de ampêres de partida a frio	CA(MCA) : 250~1190	
	DIN : 105~600	EN : 185~900
	SAE : 200~950	IEC : 125~710
Gama	Voltagem : 0.01V CCA : 1CCA	
Precisão	Voltagem : +/- 0.05V	
Tipo de bateria disponível	Disponível para voltagem 12V (9~15V) bateria de chumbo-ácido normal (chumbo liga de cálcio) abaixo: Bateria selada livre de manutenção, bateria tipo padrão, bateria EFB (bateria de célula inundada aprimorada), bateria AGM (tapete de vidro absorvente). Não disponível para bateria de ferro de lítio.	
Proteção de polaridade reversa	Reverse protection<20V DC	
Temperatura de operação	0° C~50° C (32° F~122° F)	
Temperatura de armazenamento	-30° C~70° C (-22° F~158° F)	



6 PC. Jogo de chaves para sangrar travões

108.00€

9BC5001MR

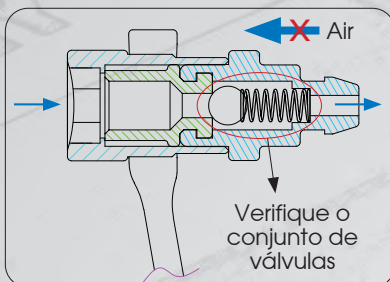

Caixa tam. (mm) :
260 x 160 x 60 (0.08 cuft)

Conteúdo

Kg 0.73 1 / 10

	9BC5107M	7mm
	9BC5108M	8mm
	9BC5109M	9mm
	9BC5110M	10mm
	9BC5111M	11mm
	9BC32P021	







5 PC. Kit teste fugas (CO2) das cabeças

120.00€

9TO41

Conteúdo

	Câmaras de teste horizontais x 1 PC
	Bulbo de borracha x 1 PC
	Adaptador cônico x 1 PC
	Testador de fluido de CO2 x 1 PC
	Garrafa x 1 PC

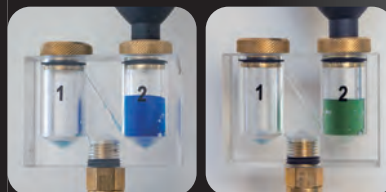

- Se o líquido do detector ainda estiver azul durante a operação de teste, significa que a junta se mantém em boas condições
- Se o gás de escape estiver presente no sistema de refrigeração, a cor do líquido de teste muda de azul para verde ou amarelo quando o vapor se mistura com o líquido do detector de CO2

6 PC. 3/8"DR. Jogo de chaves de caixa para velas 6PT 16mm 160mmL

79.00€

3716MR



• Tam. : 8, 9, 10, 12, 14, 16 mm

Alavanca p/soltar grampos

4.20€

43280212



7.15€

48280180



Alicate para remoção de molas de painéis

23.30€

9TC101



4 PC. Jogo de pinças de descofragem

- 9TK108 pé de cabra
- 9TK112 pé de cabra
- 9TK118 pé de cabra
- 9TK124 pé de cabra

46.00€

9TK014



4 PC. Jogo de alavancas cabeça curva - Para alinhamento

- 9TK306- L: 151 mm
- 9TK312- L: 305 mm
- 9TK316- L: 405 mm
- 9TK320- L: 504 mm

55.00€

9TK034



Mini-gancho para orings e vedantes

- 43350175Y-Precisão 45°-Palheta dobrada
- 43360175Y-Precisão Hook-Pick
- 43370175Y-Precisão 90°-Palheta dobrada
- 43390175Y-Precisão Direto

11.00€

30914AY



Proteção de guarda lamas 1050*650mm

28.00€

9TP11



- proteção contra riscos, mossa ou sujidade
- Acessório magnético para manter a pintura protegida
- Áspero, imitação de couro, alcochoado e com bordas reforçadas

4 PC. Jogo de alavancas JUMBO

- L: 625 mm
9TK225A-90°
9TK225B-45°
- L: 920 mm
9TK236A-30°
9TK236B-Straight

206.00€

9TK024



Bandeja de drenagem de óleo



15.00€

9TT11-18



Conteúdo :

- Capacidade de 18 litros
- Borda anti-respingo
- Bica integral
- Ideal para drenar anticongelante ou óleo
- Atende às normas da PAHS



Rastejador de plástico

58.00€

87C23-B

• Tam. : 1010 x 475 x 130 (40")



Rastejador de aço

52.00€

87C24-B



87C24-B

• Tam. : 920 x 425 x 95 (36")

70.00€

87C25-B



87C25-B

• Tam. : 1020 x 425 x 110 (40")

Banco de trabalho com rodas giratórias 360°

150
kg

95.00€

87452C-B



• Quatro rodízios giratórios de 360°

Bandeja de metal

• Tam. : 350 x 260 x 240 mm

- Material: couro PVC + almofada de espuma + acabamento em aço com revestimento em pó
- Duas áreas de armazenamento abertas

Equipamento de Garagem

MACACO GARRAFA- SERIE PROFESSIONAL

9TY111



• Altura ajustável



REF ^o	Capacd.(T)	Altura ajustável (mm)	Altura mín. (mm)	Altura max. (mm)	N.W (kg)	G.W (kg)	CUFT	€
9TY111-035A-B	3.5	88	172	372	22.74	23.70	0.86	52.00
9TY111-05A-B	5	110	218	474	29.34	30.30	1.12	56.00
9TY111-10A-B	10	115	220	488	36.85	37.80	1.33	85.00
9TY111-15A-B	15	113	228	508	49.35	50.60	3.05	102.00
9TY111-20A-B	20	110	241	525	52.28	53.28	1.49	125.00

MACACO GARRAFA

9TY112

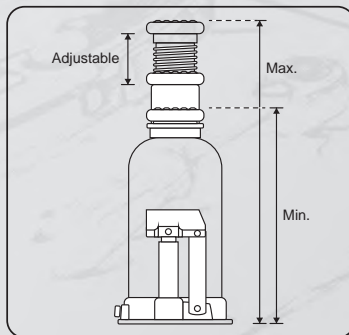

REF ^o	Capacd.(T)	Altura ajustável(mm)	Altura mín. (mm)	Altura max. (mm)	N.W (kg)	G.W (kg)	CUFT	€
9TY112-02A-B	2	48	175	339	12.48	13.08	0.59	25.00
9TY112-03A-B	3	60	190	368	16.92	17.82	0.79	28.00
9TY112-04A-B	4	60	190	368	16.92	17.82	0.79	28.00
9TY112-05A-B	5	70	210	407	14.88	15.68	0.67	34.00
9TY112-06A-B	6	70	210	407	14.88	15.68	0.67	34.00
9TY112-08A-B	8	80	225	440	18.80	19.36	0.74	41.00
9TY112-10A-B	10	80	225	440	18.80	19.36	0.74	42.00
9TY112-12A-B	12	80	230	465	18.80	18.36	0.64	49.00
9TY112-15A-B	15	80	230	460	13.88	14.14	0.51	55.00
9TY112-16A-B	16	80	230	460	13.88	14.14	0.51	55.00
9TY112-20A-B	20	60	240	450	17.56	17.96	0.57	67.00
9TY112-32A-B	32	-	260	430	17.80	18.05	0.47	130.00
9TY112-50A-B	50	-	280	470	25.80	26.05	0.59	176.00

MACACO RODAS ALUMINIO 3T

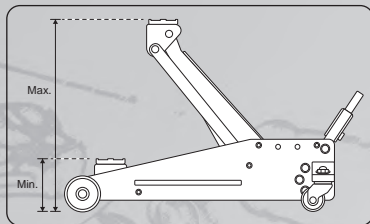

REFª	Capacd.(T)	Altura mín. (mm)	Altura max. (mm)	N.W (kg)	G.W (kg)	CUFT
9TY153-03A-B	3	100	465	26.8	28.5	1.73

Macaco de rodas rebaixado 2,5 Ton

- Regulação de velocidade hidráulica
- Design de perfil extra baixo
- Alça de transporte extra para transporte conveniente

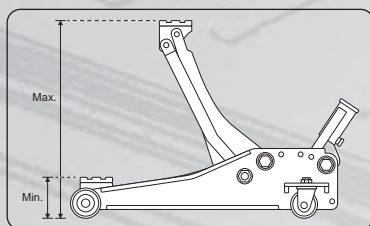

REFª	Capacd. (T)	Altura mín. (mm)	Altura max. (mm)	N.W (kg)	G.W (kg)	CUFT
9TY133A-25A-B	2.5	75	515	34.1	36	2.04

MACACO RODAS LONGO(H: 150-560 MM)

- Ideal para levantar camiões pesados e autocarros
- Dispositivo de pedal extra permite configuração e elevação rápidas

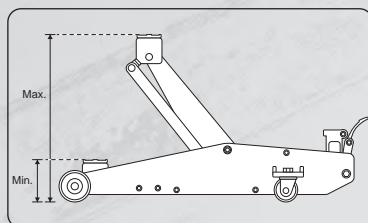

9TY131



REFª	Capacd.(T)	Altura mín. (mm)	Altura max. (mm)	N.W (kg)	G.W (kg)	CUFT	€
9TY131A-03A-B	3	140	700	54	60	9.50	437.00
9TY131-05A-B	5	150	570	85	100	12.52	770.00

CAVALETE CREMALHEIRA

- Com um pino de travamento seguro
- Base de aço com pernas grandes para maior suporte e resistência



• Base de aço

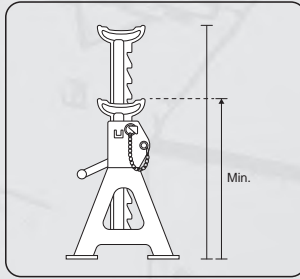

9TY342



REF ^o	Capacd. (T)	Altura mín. (mm)	Altura max. (mm)	N.W (kg)	G.W (kg)	CUFT	€
9TY342-02A-B	2	285	425	5.46	5	0.51	41.00
9TY342-06A-B	6	465	715	14.3	13.5	1.42	137.00

MACACO TRANSMISSÕES 0,5T (H: 1135-1950 M)

263.00€

9TY1421-05A-B

REF ^o	Capacd. (T)	Altura mín. (mm)	Altura max. (mm)	N.W (kg)	G.W (kg)	CUFT
9TY1421-05A-B	0.5	1140	1965	24	28.5	1.7



BARRA SUPORTE DE MOTORES 0,5T

- Suporta facilmente o motor ao remover a transmissão
- A almofada de borracha evita o deslizamento durante a operação, bem como danos à superfície da carga

135.00€

9TY611-05A-B

REF ^o	Capacd. (T)	comprimento da travessa (mm)	N.W (kg)	G.W (kg)	CUFT
9TY611-05A-B	0.5	1500	16	17	1.14



GRUA 2T REBATÍVEL

- Grande cilindro de aço hidráulico para carga de segurança
- Corpo dobrável
- O braço de levantamento de posição de 4 furos fornece capacidade de carga diferentes.

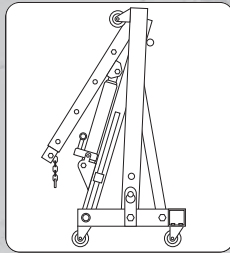
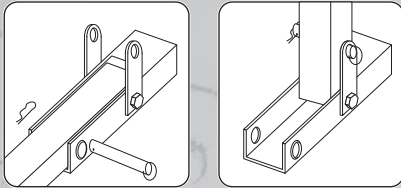

589.00€
9TY1342-02A-B



• Punho giratório 360°

• Serie ligeira (80mm)

REFª	Capacd. (T)	Elevação(mm)	Compr. (mm)	Largura (mm)	Altura(mm)	N.W (kg)	G.W (kg)	CUFT
9TY1342-02A-B	2	25-2400	1590	1100	1416	98.22	101.56	5.41

CAVALETE SUPORTE DO MOTOR

- Suporte do motor é projetado para motores V4, V6 e V8
- Rodízios giratórios dianteiros facilitam o movimento
- A construção precisa em aço resistente fornece estabilidade e resistência
- Fácil e rápido de montar e desmontar



- rotação de 360 graus
- Quatro braços ajustáveis



113.00€
9TY135-100A-B

9TY135-100A-B



143.00€
9TY135-125A-B

9TY135-125A-B

REFª	Capacd.(LBS)	N.W (kg)	G.W (kg)	CUFT
9TY135-100A-B	1000	21	22.3	1.20
9TY135-125A-B	1250	27.5	29.2	1.47



TESTE INJECTORES 220V

1034.00€
9DEP316AA-B

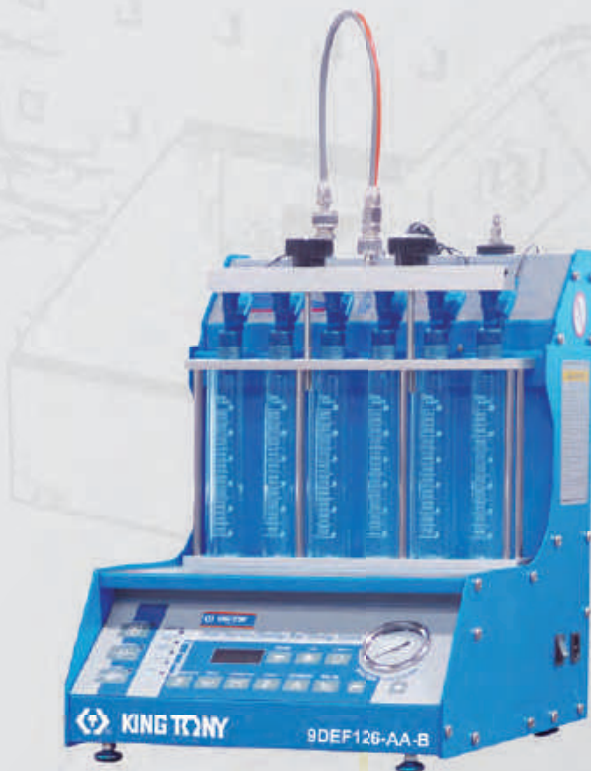

REF ²	Tensão de entrada	Temperatura ambiente	poder ultra-sônico	tempo de pulverização	Volume do cilindro	N.W (kg)	G.W (kg)	CUFT	CTN/BOX
9DEP316AA-B	220V 50Hz/1PH	-10~38 °C	100 w	0-10 min	120 ml	19	21.5	6.19	1/1

ASPIRADOR DE ÓLEO PNEUMÁTICO

9TVP1



REF ²	Capacid.	Pressão de entrada de ar	Conexão de entrada de ar	Nível de temp. do óleo	N.W (kg)	G.W (kg)	CUFT	€
9TVP1-65A-B	65 L / 17.1 US Gallon	87-116 psi	1/4"	40-60 °C	21.8	25	8.34	408.00
9TVP1-80A-B	80 L / 21.1 US Gallon	87-116 psi	1/4"	40-60 °C	26.1	29.7	12.45	525.00

DISTRIBUIDOR DE ÓLEO MANUAL 30 LT

- Capacidade.: 30L / 8 Galões
- Mangueira do dispensador: \varnothing 12 mm x 8 mm
- Comprimento da pistola dispensadora: 130 mm



232.00€

9TWP2-30A-B



Alavanca extratora do terminal do braço oscilante da suspensão e amortecedores

167.00€

9BJ21

5,6 Kg

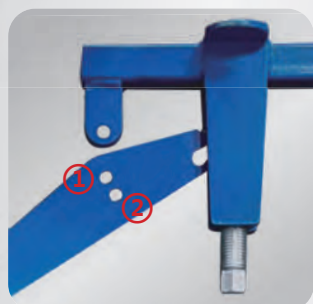
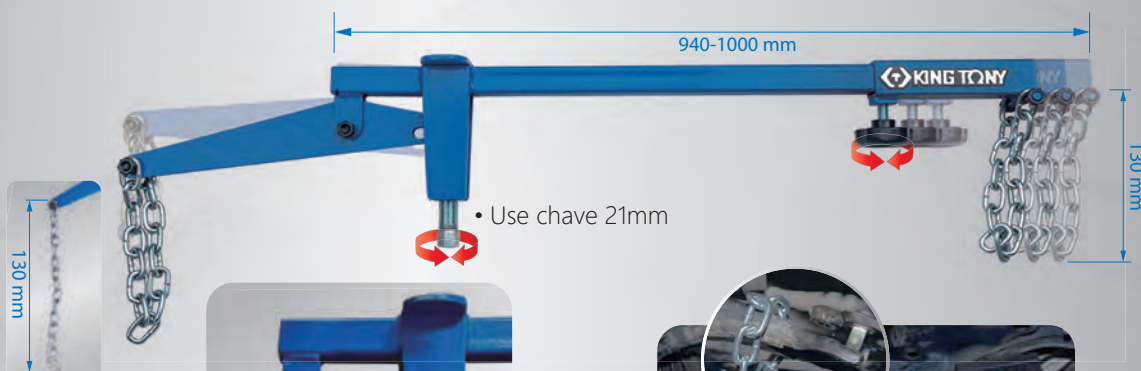

- Ajuste de duas posições





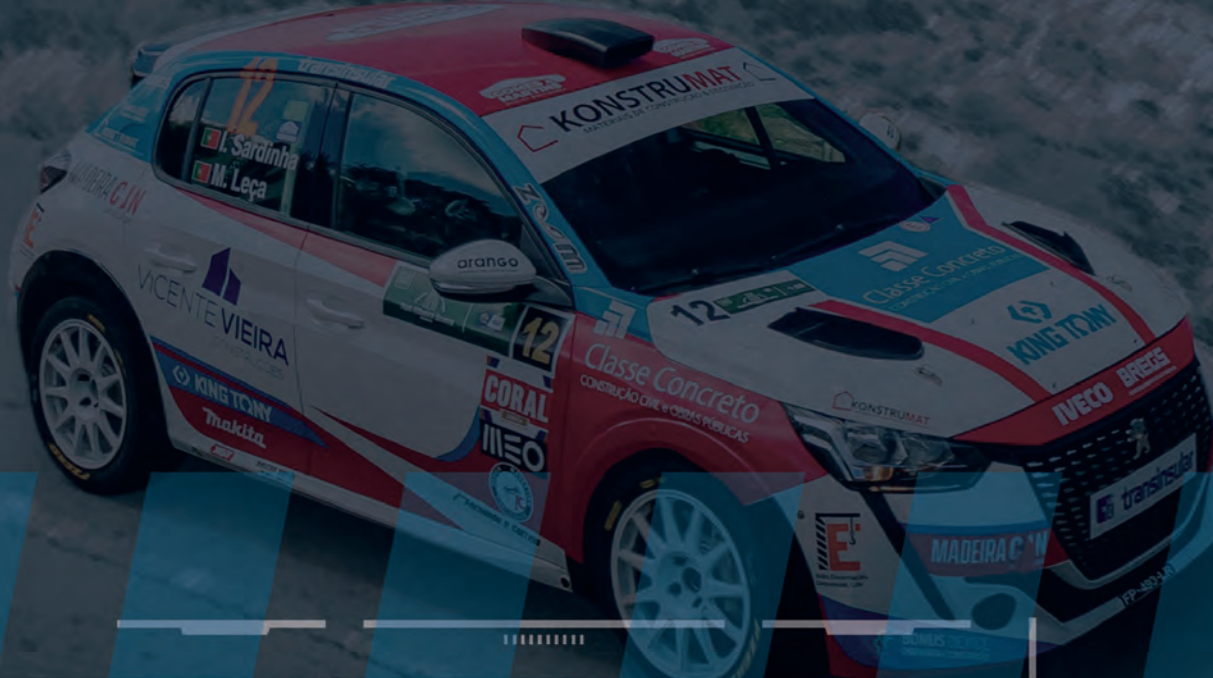

Distribuição em Portugal Lusaveiro, S.A.

Edifício LUSAVEIRO
Rua da Paz , Quintã do Loureiro 3800-587 Cacia
Telef. +351 234 303 082
Fax +351 234 303 090
E-mail: geral@lusaveiro.pt

 **KING TONY TOOLS CO.,LTD.**

<http://www.kingtony.com>

✉ service@kingtony.com.tw



facebook  YouTube

king tony 

 Instagram

kingtonytools 

CATSA2023-1 LU